

Solve problems involving measurement and conversion of measurements from a larger unit to a smaller unit (Standards 4.MD.1–2)	
<p><b>Standard 4.MD.1</b> Know relative sizes of measurement units within each system of units (standard and metric), including kilometers, meters, and centimeters; liters and milliliters; kilograms and grams; pounds and ounces; hours, minutes, and seconds. Within a single system of measurement, express measurements in a larger unit in terms of a smaller unit. Record measurement equivalents in a two-column table. <i>For example, know that one foot is 12 times as long as one inch. Express the length of a four-foot snake as 48 inches. Know that one meter is 100 times as long as one centimeter. Generate a conversion table for feet and inches listing the number pairs (1, 12), (2, 24), (3, 36). . .</i></p>	
Concepts and Skills to Master	
<ul style="list-style-type: none"> <li>• Know relative sizes of measurement units using benchmarks and mental images of units introduced in previous grades (see Critical Background Knowledge below) and units new to fourth grade (kilometers, pounds, ounces, and seconds)</li> <li>• Understand that a given measurement can be expressed using different units, yet retain the same value (1 ft. can be represented as 12 in. without altering the value; 1 ft. = 12 in.)</li> <li>• Generalize the relationship between larger and smaller units (1 foot is 12 times as long as one inch)</li> <li>• Convert/Express larger units in terms of smaller units within the same system of measurement using multiplication (converting smaller units to larger units using division begins in fifth grade)</li> </ul> <p>Teacher Note: Students should also be exposed to the following units not explicitly listed in the core standards: millimeters, miles, fluid ounces, cups, pints, quarts, and gallons. The following measurements will NOT include a conversion key for assessment purposes: Kilo-, centi-, milli- (meters); Kilo-, centi-, milli- (liters); Kilo-, centi-, milli- (grams); pounds and ounces; hours, minutes, and seconds; feet and inches. The following measurements will include a conversion key for assessment purposes: yards and miles; cups, gallons, pints, quarts, liquid ounces.</p> <p>The core standards do not differentiate between weight and mass. Technically, mass is the amount of matter in an object. Weight is the force exerted on the body of gravity. On the earth's surface, the distinction is not important. Therefore, mass and weight may be used interchangeably in solving measurement problems related to the standard.</p>	
Related Standards: Current Grade Level	Related Standards: Future Grade Levels
<p><b>4.MD.2</b> Solve word problems involving distances, intervals of time, liquid volumes, masses of objects, and money</p> <p><b>4.OA.1</b> Interpret a multiplication equation as a comparison</p> <p><b>4.OA.2</b> Multiply to solve word problems involving multiplicative comparison</p>	<p><b>5.MD.1</b> Use unit conversions in solving multi-step, real world problems</p> <p><b>6.RP.3.d</b> Use ratio reasoning to convert measurement units; manipulate and transform units appropriately when multiplying or dividing quantities</p>
Critical Background Knowledge	
<ul style="list-style-type: none"> <li>• <b>Distances:</b> Measure lengths with halves and fourths of an inch (3.MD.4); Estimate, measure, add, and subtract lengths using inches, feet, yards, centimeters, and meters (2.MD.1-6)</li> <li>• <b>Liquid Volumes:</b> Measure and estimate masses of objects using grams and kilograms and liquid volumes using milliliters and liters (3.MD.2)</li> <li>• <b>Masses of objects:</b> Measure and estimate; add, subtract, multiply, or divide to solve one-step word problems given the same units (3.MD.2)</li> <li>• <b>Time:</b> Tell and write time to the nearest minute. Add and subtract time intervals in minutes using number line diagrams (3.MD.1); Tell and write time to the nearest 5 minutes using a.m. and p.m. (2.MD.7)</li> </ul>	

Academic Vocabulary

**Distances:** metric system, distance, length, Kilometer (km), meter (m), centimeter (cm), standard/customary system, mile (mi.), yard (yd.)  
feet (ft.) inch (in.)

**Liquid volumes:** liquid volume, capacity, liter (l), milliliter (ml), gallon (gal.), quart (qt.), pint (pt.), cup (c.), fluid ounce (fl. oz.)

**Masses of objects:** mass, weight, kilogram (kg), gram (g), pound (lb.), ounce (oz.)

**Time:** hour (hr.), minute (min.), second (sec.)

Suggested Models

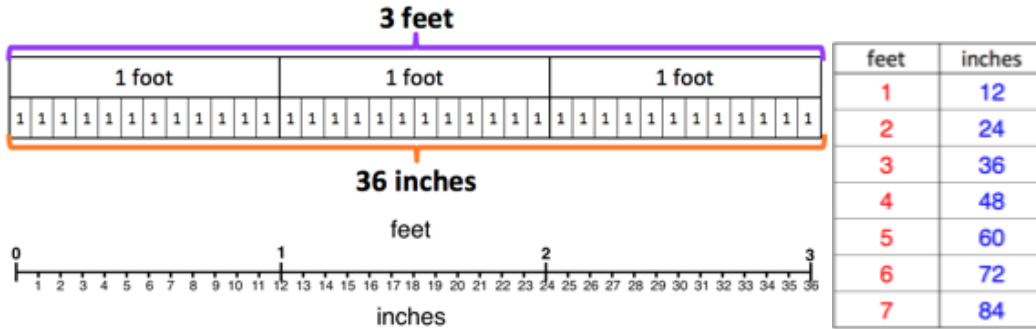

Suggested Strategies

- Measure the same object using two different units, then compare the measurements to the size of the units being used
- Draw pictures and models to generalize conversions (see the image to the left)
- Create a two-column chart or table to notice any patterns for converting within given measurements (see the table to the left)

Solve problems involving measurement and conversion of measurements from a larger unit to a smaller unit (Standards 4.MD.1–2)	
<p><b>Standard 4.MD.2</b> Use the four operations to solve word problems involving distances, intervals of time, liquid volumes, masses of objects, and money.</p> <p><b>a.</b> Include problems involving simple fractions or decimals, and problems that require expressing measurements given in a larger unit in terms of a smaller unit.</p> <p><b>b.</b> Represent measurement quantities using diagrams such as number line diagrams that feature a measurement scale.</p>	
Concepts and Skills to Master	
<ul style="list-style-type: none"> <li>• Know relative sizes of measurement units using benchmarks and mental images of units introduced in previous grades (see Critical Background Knowledge below) and units new to fourth grade (kilometers, pounds, ounces, and seconds)</li> <li>• Add, subtract, multiply, or divide with whole numbers to solve word problems involving measurement units</li> <li>• Express larger units in terms of smaller units</li> <li>• Add simple decimals including tenths and hundredths in which the sum of the two decimals is less than or equal to 0.99 and NO composing across place values (regrouping) is required (<math>0.5 + 0.4 = 0.9</math>; <math>0.25 + 0.3 = 0.55</math>). (Students are not expected to operate with decimals outside of these parameters until 5th grade. In 4.NF.5, students add fractions with denominators 10 and 100. In 4.NF.6, students express fractions with denominators 10 and 100 using decimal notation.)</li> <li>• Use decimal notation to represent money (<math>\\$0.75</math> is another notation for 75¢)</li> <li>• Add and subtract simple fractions with like denominators including denominators of 2, 3, 4, 5, 6, 8, 10, 12, or 100 (see 4.NF.3)</li> <li>• Measure time intervals (elapsed time) and solve word problems involving addition and subtraction of time intervals using hours, minutes, and seconds</li> </ul> <p>Teacher Note: Students combine competencies from other Strands (Numbers and Operations-Fractions, etc.) to solve measurement problems. The Core Standards do not have an exhaustive list of measurement units students work with. Students should also be exposed to the following units not explicitly listed in the Core Standards: millimeters, miles, fluid ounces, cups, pints, quarts, and gallons. Students should not be expected to memorize unit conversions; however, knowing relative sizes of measurement units within systems of units and having repeated exposure to commonly used units will support them in being able express measurements in a larger unit in terms of a smaller unit.</p>	
Related Standards: Current Grade Level	Related Standards: Future Grade Levels
<p><b>4.MD.1</b> Know relative sizes of measurement units and express units in a larger unit in terms of a smaller unit using a two-column table</p> <p><b>4.OA.3</b> Solve multi-step word problems using the four operations</p> <p><b>4.NF.3</b> Add and subtract fractions with like denominators</p> <p><b>4.NF.4</b> Multiply a fraction by a whole number</p> <p><b>4.NF.5</b> Add fractions with denominators of 10 and 100</p> <p><b>4.NF.6</b> Use decimal notation for fractions with denominators 10 or 100</p>	<p><b>5.MD.1</b> Use unit conversions in solving multi-step, real world problems</p> <p><b>5.NF.5</b> Interpret multiplication as scaling</p> <p><b>6.RP.2</b> Understand and use unit rates in the context of ratio relationships</p>
Critical Background Knowledge	
<ul style="list-style-type: none"> <li>• <b>Distances:</b> Measure lengths with halves and fourths of an inch (3.MD.4); Estimate, measure, add, and subtract lengths using inches, feet, yards, centimeters, and meters (2.MD.1-6)</li> <li>• <b>Liquid Volumes:</b> Measure and estimate masses of objects using grams and kilograms and liquid volumes using milliliters and liters (3.MD.2)</li> <li>• <b>Masses of objects:</b> Measure and estimate; add, subtract, multiply, or divide to solve one-step word problems given the same units (3.MD.2)</li> <li>• <b>Intervals of time:</b> Tell and write time to the nearest minute. Add and subtract time intervals in minutes using number line diagrams (3.MD.1); Tell and write time to the nearest 5 minutes using a.m. and p.m. (2.MD.7)</li> <li>• <b>Money:</b> Solve word problems involving dollar bills, quarters, dimes, nickels, and pennies using \$ and ¢ symbols (2.MD.8); Identify the value of pennies, nickels, dimes and quarters (1.MD.5)</li> </ul>	

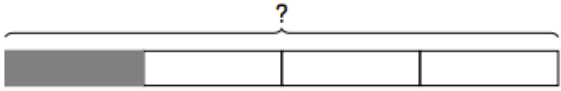
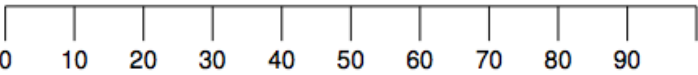
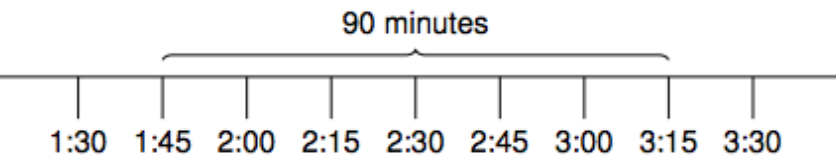
Academic Vocabulary	
<p><b>Distances:</b> metric system, distance, length, Kilometer (km), meter (m), centimeter (cm), millimeter (mm), standard/customary system, mile (mi.), yard (yd.) feet (ft.) inch (in.)</p> <p><b>Intervals of time:</b> elapsed time, time interval, hour (hr.), minute (min.), second (sec.)</p> <p><b>Liquid volumes:</b> liquid volume, capacity, liter (l), milliliter (ml), gallon (gal.), quart (qt.), pint (pt.), cup (c.), fluid ounce (fl. oz.)</p> <p><b>Masses of objects:</b> mass, weight, kilogram (kg), gram (g), pound (lb.), ounce (oz.)</p> <p><b>Money:</b> value, dollar (\$), cent (¢)</p>	
Suggested Models	Suggested Strategies
<p>Use number line diagrams to solve word problems</p> <p><i>Juan spent <math>\frac{1}{4}</math> of his money on a game. The game cost \$20. How much money did he have at first?</i></p>   <p><i>What time does Marla have to leave to be at her friend's house by a quarter after 3 if the trip takes 90 minutes?</i></p>  <p>Using a number line diagram to represent time is easier if students think of digital clocks rather than round clocks. In the latter case, placing the numbers on the number line involves considering movements of the hour and minute hands.</p>	<ul style="list-style-type: none"> <li>• Solve measurement word problems including operations of addition, subtraction, multiplication, and division using visual models including number lines, base ten blocks, and drawings</li> <li>• Create a two-column chart or table to notice any patterns for converting within given measurements</li> <li>• Use number line diagrams to solve word problems</li> </ul>
Image Source: <a href="https://commoncoretools.files.wordpress.com/2012/07/ccss_progression_gm_k5_2012_07_21.pdf">https://commoncoretools.files.wordpress.com/2012/07/ccss_progression_gm_k5_2012_07_21.pdf</a>	

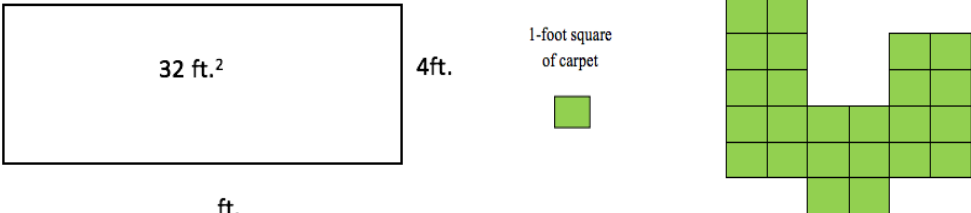
Apply knowledge of area and perimeter to solve real world and mathematical problems (Standard 4.MD.3)	
<b>Standard 4.MD.3</b> Apply the area and perimeter formulas for rectangles in real-world and mathematical problems. <i>For example, find the width of a rectangular room given the area of the flooring and the length, by viewing the area formula as a multiplication equation with an unknown factor.</i>	
Concepts and Skills to Master	
<ul style="list-style-type: none"> <li>• Apply the area formula to solve real world problems</li> <li>• Apply the perimeter formula(s) to solve real world problems</li> <li>• Understand the meaning of and solve for variables in area and perimeter formulas</li> </ul> <p>Teacher Note: "Apply the formula' does not mean write down a memorized formula and put in known values. . . Working with perimeter and area of rectangles is still grounded in specific visualizations and numbers. . . By repeatedly reasoning about constructing situation equations for perimeter and area involving specific numbers and an unknown number, students will build a foundation for applying area, perimeter, and other formulas by substituting specific values for the variables in later grades." (<a href="https://commoncoretools.files.wordpress.com/2012/07/ccss_progression_gm_k5_2012_07_21.pdf">https://commoncoretools.files.wordpress.com/2012/07/ccss_progression_gm_k5_2012_07_21.pdf</a>, p. 22)</p>	
Related Standards: Current Course	Related Standards: Future Courses
<p><b>4.NBT.4</b> Fluently add and subtract multi-digit whole numbers</p> <p><b>4.NBT.5</b> Multiply a whole number of up to four digits by a one-digit whole number and multiply two two-digit numbers</p> <p><b>4.OA.3</b> Solve multi-step word problems with whole numbers</p>	<p><b>5.MD.5</b> Relate volume to the operations of multiplication and addition and solve real-world problems involving volume</p> <p><b>6.G.1</b> Find the area of right triangles, other triangles, special quadrilaterals, and polygons by composing and decomposing into rectangles, triangles and /or other shapes; apply these techniques in the context of solving real-world problems</p>
Critical Background Knowledge from Previous Grade Levels	
<ul style="list-style-type: none"> <li>• Solve real-world and mathematical problems involving perimeters of polygons, including finding the perimeter given the side lengths, finding an unknown side length, and exhibiting rectangles with the same perimeter and different areas or with the same area and different perimeters (3.MD.8)</li> <li>• Relate area to the operations of multiplication and addition (3.MD.7)</li> <li>• Use multiplication and division within 100 to solve real-world problems (3.OA.3)</li> <li>• Determine the unknown whole number in a multiplication or division equation relating three whole numbers (3.OA.4)</li> <li>• Solve two-step word problems using the four operations using whole numbers (3.OA.8)</li> </ul>	
Academic Vocabulary	
rectangle, perimeter, area, array, unit, square units, rectangular perimeter formula ( $P = 2l + 2w$ ), rectangular area formula ( $A = l \times w$ )	
Suggested Models	Suggested Strategies
 <p>Mr. Rutherford is covering the miniature golf course with an artificial grass. How many 1-foot squares of carpet will he need to cover the entire course? What is the perimeter of the figure?</p>	<ul style="list-style-type: none"> <li>• Use graph paper or square tiles to make a rectangle with no gaps or overlaps, then count the square units to find the area. Count the side lengths to find the perimeter. Compare these strategies to the formulas.</li> <li>• Solve word problems given an area and one side length by finding the unknown side</li> <li>• Read and discuss measurement word problems to identify when to solve for perimeter or area; solve the problems using models and diagrams</li> </ul>
Image Source: <a href="http://www.dpi.state.nc.us/docs/curriculum/mathematics/scos/4.pdf">http://www.dpi.state.nc.us/docs/curriculum/mathematics/scos/4.pdf</a>	

Represent and interpret data through the use of a line plot (Standard 4.MD.4)	
<b>Standard 4.MD.4</b> Make a line plot to display a data set of measurements in fractions of a unit (halves, quarters, and eighths). Solve problems involving addition and subtraction with like denominators of fractions by using information presented in line plots. <i>For example, use a line plot to find and interpret the difference in length between the longest and shortest pencils in a classroom.</i>	
Concepts and Skills to Master	
<ul style="list-style-type: none"> <li>• Make a line plot using provided data sets; include a horizontal scale, title, labels, and straight columns of symbols to represent the data points (• or X)</li> <li>• Use a variety of strategies to solve addition and subtraction problems related to data on a line plot</li> </ul> <p>Teacher Note: In fourth grade students are not expected to generate measurement data. However, third grade students only measure to the fourth of an inch. This standard is an appropriate place for students to learn to measure to the eighth of an inch.</p>	
Related Standards: Current Grade Level	Related Standards: Future Grade Levels
<p><b>4.MD.2</b> Use the four operations to solve word problems, including simple fractions and represent measurement quantities using diagrams</p> <p><b>4.NF.1</b> Explain why fractions are equivalent and generate equivalent fractions</p> <p><b>4.NF.3c</b> Add and subtract mixed numbers with like denominators</p>	<p><b>5.MD.2</b> Make line plots with measurements to the half, quarter, and eighth of a unit. Solve problems involving operations of fractions.</p> <p><b>5.NF.2</b> Solve real world problems involving the addition and subtraction of fractions referring to the same whole, including cases of unlike denominators</p>
Critical Background Knowledge from Previous Grade Levels	
<ul style="list-style-type: none"> <li>• Generate measurement data by measuring lengths using rulers marked with halves and fourths of an inch. Show the data by making a line plot where the horizontal scale is marked off in appropriate units-whole numbers, halves, or quarters (3.MD.4)</li> <li>• Understand line plots represent measurement data, not categorical data (3.MD.3, 3.MD.4)</li> <li>• Generate measurement data and make line plots using whole number units (2.MD.9)</li> </ul>	
Academic Vocabulary	
line plot, fraction, measurement, data, data set, unit	
Suggested Models	Suggested Strategies
	<ul style="list-style-type: none"> <li>• Generate ideas about what measurement data could be generated and represented on a line plot</li> <li>• Measure physical objects or distances varying in length; use data to create a line plot</li> <li>• Students may use tally marks or data tables to record measurements prior to creating a line plot or they may produce the line plot as the data are being collected</li> </ul>
Image Source: <a href="http://www.dpi.state.nc.us/docs/curriculum/mathematics/scos/4.pdf">http://www.dpi.state.nc.us/docs/curriculum/mathematics/scos/4.pdf</a>	

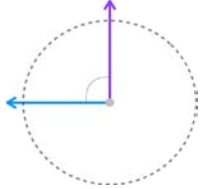
Understand various concepts of angles and angle measurement (Standard 4.MD.5–7).													
<p><b>Standard 4.MD.5</b> Recognize angles as geometric figures that are formed wherever two rays share a common endpoint, and understand concepts of angle measurement.</p> <p>a. Understand that an angle is measured with reference to a circle with its center at the common endpoint of the rays, by considering the fraction of the circular arc between the points where the two rays intersect the circle. An angle that turns through <math>\frac{1}{360}</math> of a circle is called a "one-degree angle," and can be used to measure other angles.</p> <p>b. Understand that an angle that turns through <math>n</math> one-degree angles is said to have an angle measure of <math>n</math> degrees.</p>													
Concepts and Skills to Master													
<ul style="list-style-type: none"> <li>Understand that angles are measured with reference to a circle with its center at the common endpoint of the ray</li> <li>Understand that the arc between the points where the rays intersect is a fraction of the circle</li> <li>Recognize angles as geometric figures that are formed wherever two rays share a common endpoint</li> <li>Understand that a one-degree angle means the angle has turned <math>\frac{1}{360}</math> of a circle</li> <li>Understand that the number of one-degree angles an angle turns through is the number of degrees the angle measures</li> </ul> <p>Teacher Note: This standard brings up a connection between angles and circular measurement (360 degrees). In fourth grade students should be exposed to and become familiar with half-circle protractors (physical and digital) with the numbers going in both directions.</p>													
Related Standards: Current Grade Level	Related Standards: Future Grade Level												
<p><b>4.MD.6</b> Measure angles in whole-number degrees using a protractor</p> <p><b>4.MD.7</b> Recognize angle measures as additive and solve to find unknown angles</p> <p><b>4.G.1</b> Draw and identify lines and angles</p> <p><b>4.G.2</b> Classify two-dimensional figures based on lines and angles</p>	<p><b>7.G.2</b> Construct triangles from three measures of angles</p> <p><b>7.G.5</b> Use facts about supplementary, complementary, vertical, and adjacent angles in a multi-step problem to write, and use them to solve simple equations for an unknown angle in a figure</p>												
Critical Background Knowledge from Previous Grade Levels													
<ul style="list-style-type: none"> <li>Students recognize the number of angles in shapes in previous grade levels, but measuring angles is not addressed in previous grades</li> <li>Understand that shapes in different categories may share attributes (3.G.1)</li> <li>Recognize and draw shapes having specified attributes, such as a given number of angles (2.G.1)</li> </ul>													
Academic Vocabulary													
circular arc, angle, vertex, circle, ray, degree, degree symbol ( $^{\circ}$ ), endpoint, one-degree, $360^{\circ}$ , center, fraction													
Suggested Models	Suggested Strategies												
<p>Pose the question: A water sprinkler rotates one-degree at each interval. If the sprinkler rotates a total of <math>100^{\circ}</math>, how many one-degree turns has the sprinkler made?</p>  <table border="1" data-bbox="508 1263 949 1416"> <caption>An angle</caption> <thead> <tr> <th>name</th> <th>measurement</th> </tr> </thead> <tbody> <tr> <td>right angle</td> <td><math>90^{\circ}</math></td> </tr> <tr> <td>straight angle</td> <td><math>180^{\circ}</math></td> </tr> <tr> <td>acute angle</td> <td>between <math>0</math> and <math>90^{\circ}</math></td> </tr> <tr> <td>obtuse angle</td> <td>between <math>90^{\circ}</math> and <math>180^{\circ}</math></td> </tr> <tr> <td>reflex angle</td> <td>between <math>180^{\circ}</math> and <math>360^{\circ}</math></td> </tr> </tbody> </table>	name	measurement	right angle	$90^{\circ}$	straight angle	$180^{\circ}$	acute angle	between $0$ and $90^{\circ}$	obtuse angle	between $90^{\circ}$ and $180^{\circ}$	reflex angle	between $180^{\circ}$ and $360^{\circ}$	<ul style="list-style-type: none"> <li>Connect prior knowledge of clocks to the concept of <math>360^{\circ}</math> in a circle</li> <li>Use arms to make angles</li> <li>Use a variety of manipulatives to demonstrate angle rotations for example licorice, cardboard and brad fastener, straws, clay, etc.</li> <li>Find, identify, and discover examples of angles in the classroom or environment</li> </ul>
name	measurement												
right angle	$90^{\circ}$												
straight angle	$180^{\circ}$												
acute angle	between $0$ and $90^{\circ}$												
obtuse angle	between $90^{\circ}$ and $180^{\circ}$												
reflex angle	between $180^{\circ}$ and $360^{\circ}$												
Image Source: Advantage Math Davis School District, <a href="https://www.cgcs.org/cms/lib/DC00001581/Centricity/Domain/120/ccss_progression_gm_k5_2012_07_21.pdf">https://www.cgcs.org/cms/lib/DC00001581/Centricity/Domain/120/ccss_progression_gm_k5_2012_07_21.pdf</a>													

Understand various concepts of angles and angle measurement (Standard 4.MD.5–7).	
<b>Standard 4.MD.6</b> Measure angles in whole-number degrees using a protractor. Sketch angles of specified measure.	
Concepts and Skills to Master	
<ul style="list-style-type: none"> <li>• Understand how use a protractor to measure angles</li> <li>• Measure angles in whole-number degrees with a protractor</li> <li>• Sketch angles of specified measures with a protractor</li> <li>• Understand benchmark angles: <math>0^\circ</math>, <math>45^\circ</math>, <math>90^\circ</math>, <math>180^\circ</math>, <math>360^\circ</math></li> <li>• Read notation to name angles <math>\angle ABC</math></li> <li>• Read different notations of angle measures (<math>90^\circ</math> is the same as <math>\square</math>)</li> </ul> <p>Teacher Note: Before students begin measuring angles with protractors, they need experience with benchmark angles. They transfer their understanding that a <math>360^\circ</math> rotation about a point makes a complete circle to recognize and sketch angles that measure approximately <math>90^\circ</math> and <math>180^\circ</math>. They extend this understanding to recognize and sketch angles that measure approximately <math>45^\circ</math> and <math>30^\circ</math>. In fourth grade students should be exposed to and become familiar with half-circle protractors (physical and digital) with the numbers going in both directions. Students are only required to <b>read</b> the angle notation, <math>\angle ABC</math>, not create it.</p>	
Related Standards: Current Grade Level	Related Standards: Future Grade Level
<p><b>4.G.1</b> Draw and identify lines and angles</p> <p><b>4.G.2</b> Classify shapes by properties of their lines and angles</p> <p><b>4.MD.5</b> Recognize and understand angles in reference to a circle</p> <p><b>4.MD.7</b> Recognize angle measures as additive and solve to find unknown angles</p>	<p><b>7.G.2</b> Construct triangles from three measures of angles</p> <p><b>7.G.5</b> Use facts about supplementary, complementary, vertical, and adjacent angles in a multi-step problem to write, and use them to solve simple equations for an unknown angle in a figure</p>
Critical Background Knowledge from Previous Grade Levels	
<ul style="list-style-type: none"> <li>• Students recognize the number of angles in shapes in previous grade levels, but measuring angles is not addressed in previous grades</li> <li>• Understand that shapes in different categories may share attributes (3.G.1)</li> <li>• Recognize and draw shapes having specified attributes, such as a given number of angles (2.G.1)</li> </ul>	
Academic Vocabulary	
angle, $\angle ABC$ , degree, degree symbol ( $^\circ$ ), ray, protractor, acute, and obtuse, benchmark angles: $0^\circ$ , $45^\circ$ , right $\square$ $90^\circ$ , straight $180^\circ$ , circle $360^\circ$	



## Suggested Models

Students should measure and sketch angles.

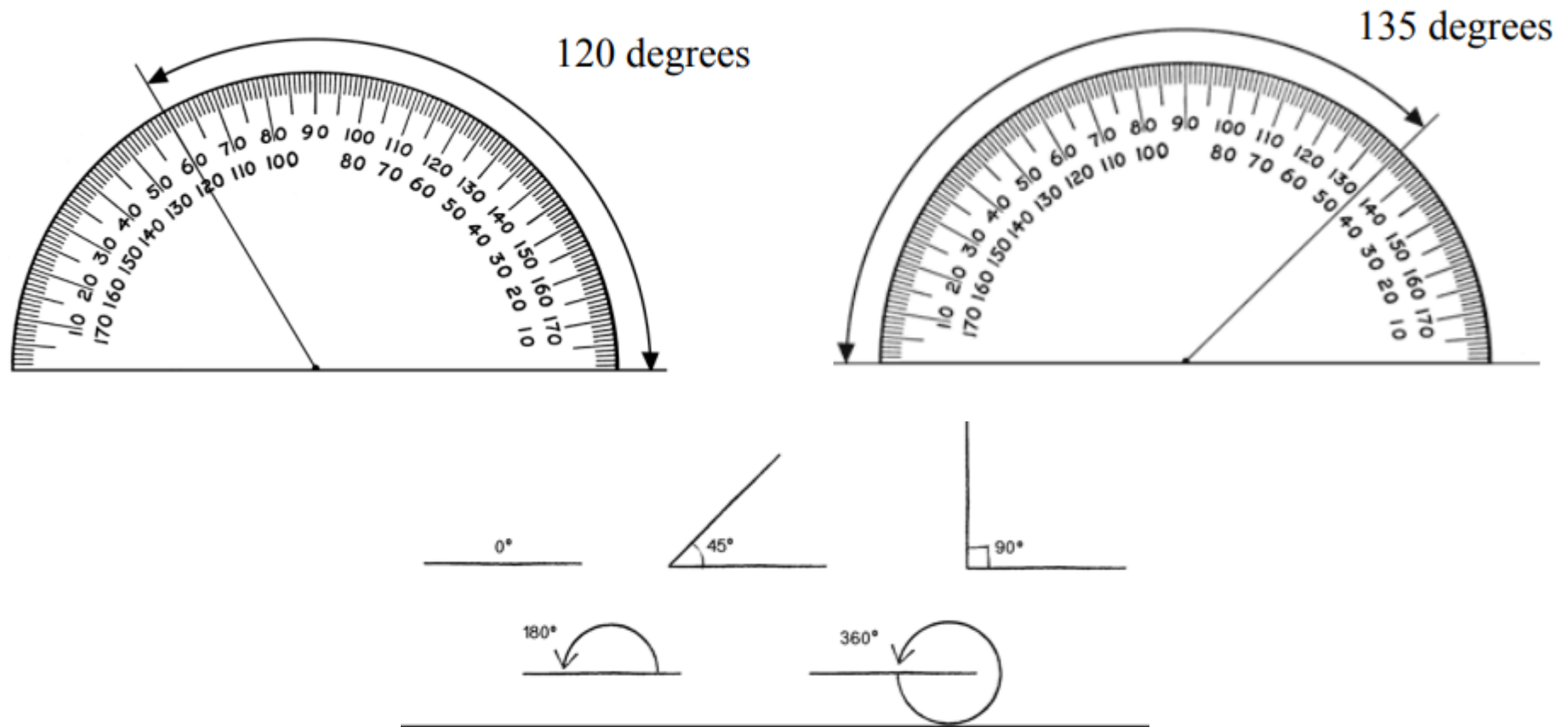

## Suggested Strategies

- Draw an angle that measures a given number of degrees
- Show angles in multiple orientations
- Give students an angle and have them estimate the degree of the angle using their understanding of benchmark angles
- Invite students to use an index card marked  $90^\circ$  or a protractor to measure angles in the classroom that are exactly  $90^\circ$ , less than  $90^\circ$ , and more than  $90^\circ$

Image Source: <http://www.dpi.state.nc.us/docs/curriculum/mathematics/scos/4.pdf>

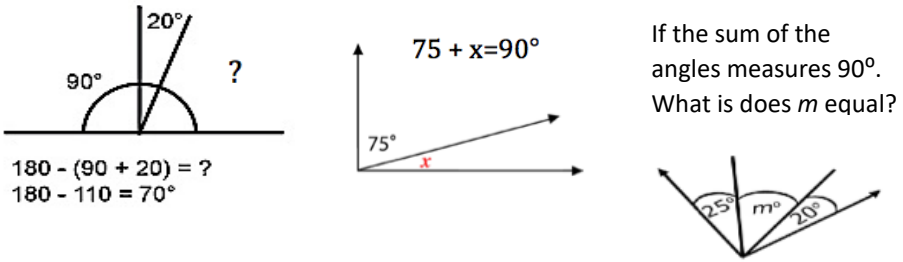
Understand various concepts of angles and angle measurement (Standard 4.MD.5–7).	
<b>Standard 4.MD.7</b> Recognize angle measure as additive.	
<p><b>a.</b> Understand that when an angle is decomposed into non-overlapping parts, the angle measure of the whole is the sum of the angle measures of the parts.</p> <p><b>b.</b> Solve addition and subtraction problems to find unknown angles on a diagram in real-world and mathematical problems, <i>for example by using an equation with a symbol for the unknown angle measure.</i></p>	
Concepts and Skills to Master	
<ul style="list-style-type: none"> <li>Understand two non-overlapping (adjacent) angles can be added together to find the sum of both angles</li> <li>Recognize angle measure as additive</li> <li>Solve addition and subtraction problems to find unknown angles in real-world situations</li> </ul>	
Teacher Note: Students are only required to <b>read</b> the angle notation, $\angle ABC$ , not create it. Angles labeled with measures are not always drawn to scale.	
Related Standards: Current Grade-Level	Related Standards: Future Grade-Levels
<p><b>4.MD.5</b> Recognize and understand angles in reference to a circle</p> <p><b>4.MD.6</b> Measure angles in whole-number degrees using a protractor</p>	<p><b>7.G.2</b> Construct triangles from three measures of angles</p> <p><b>7.G.5</b> Use facts about supplementary, complementary, vertical, and adjacent angles in a multi-step problem to write, and use them to solve simple equations for an unknown angle in a figure</p>
Critical Background Knowledge from Previous Grade Levels	
<ul style="list-style-type: none"> <li>Students recognize the number of angles in shapes in previous grade levels, but measuring angles is not addressed in previous grades</li> <li>Understand that shapes in different categories may share attributes (3.G.1)</li> <li>Recognize and draw shapes having specified attributes, such as a given number of angles (2.G.1)</li> <li>Use addition and subtraction within 100 to solve one- and two-step word problem (2.OA.1)</li> <li>Find the unknown whole number using addition and subtraction (1.OA.8)</li> </ul>	
Academic Vocabulary	
additive, decompose, non-overlapping (adjacent), angle, sum, degree, degree symbol $^\circ$ , acute angle, obtuse angle, straight angle, right angle, angle measure, perpendicular	
Suggested Models	Suggested Strategies
 <p>If the sum of the angles measures <math>90^\circ</math>. What is does <math>m</math> equal?</p>	<ul style="list-style-type: none"> <li>Solve problems such as the following: A lawn water sprinkler rotates 50 degrees and then pauses. It then rotates an additional 25 degrees. What is the total degrees the sprinkler has rotated? If the water sprinkler rotates a total of 25 degrees then pauses. How many 25 degree cycles will it go through for the rotation to reach at least 90 degrees?</li> </ul>
Image Source: <a href="http://www.dpi.state.nc.us/docs/curriculum/mathematics/scos/4.pdf">http://www.dpi.state.nc.us/docs/curriculum/mathematics/scos/4.pdf</a>	