

MATHEMATICS

UTAH CORE **GUIDES** GRADE 4



Use the four operations with whole numbers (addition, subtraction, multiplication, and division) to solve problems (Standards 4.OA.1–3).	
Standard 4.OA.1 Interpret a multiplication equation as a comparison (<i>for example, interpret $35 = 5 \times 7$ as a statement that 35 is 5 times as many as 7 and 7 times as many as 5</i>). Represent verbal statements of multiplicative comparisons as multiplication equations.	
Concepts and Skills to Master	
<ul style="list-style-type: none"> • Distinguish between additive comparisons and multiplicative comparisons (8 can be compared to 2 additively, 8 is 6 more than 2 and can also be compared to 2 multiplicatively, 8 is 4 times as many as 2) • Recognize that any two factors and their product can be read as a comparison (8 is 4 times as many as 2, or 2 times as many as 4 is 8) • Write multiplication equations from multiplicative comparison situations • Represent multiplicative comparisons using a variety of models and strategies <p>Teacher Note: Fourth grade is the first time that students view multiplication as a comparison. In first and second grade, students work with additive comparisons. Third grade students understand multiplication as groups or arrays of objects. In fourth grade, these understanding extend to multiplication as a comparison. Multiplicative comparison situations are more complex than equal groups and arrays, and must be carefully distinguished from additive comparison problems. This standard should be taught with Standard 4.OA.2 using the following multiplication and division situations. (See: TABLE 2. Common multiplication and division situations.)</p> <ul style="list-style-type: none"> • Compare/Larger Unknown word problems (A blue hat costs \$3. A red hat costs 4 times as much as the blue hat. How much does the red hat cost?) • Compare/Smaller Unknown word problems (A red hat costs \$12 and that is 4 times as much as a blue hat costs. How much does a blue hat cost?) • Compare/Multiplier Unknown word problems (A red hat costs \$12 and a blue hat costs \$3. How many times as much does the red hat cost as the blue hat?) 	
Related Standards: Current Grade Level	Related Standards: Future Grade Levels
<p>4.OA.2 Multiply and divide to solve word problems involving multiplicative comparisons</p> <p>4.OA.3 Solve multi-step word problems using whole numbers and having whole-number answers using the four operations</p> <p>4.MD.1 Within a single system of measurement, express measurements in a larger unit in terms of a smaller unit</p> <p>4.NF.4 Apply and extend understanding of multiplication to multiply a fraction by a whole number</p>	<p>5.NF.3 Interpret a fraction as division of the numerator by the denominator</p> <p>5.NF.4, 5.NF.5 Apply and extend previous understandings of multiplication and division to multiply a fraction or whole number by a fraction</p> <p>6.RP.1 Understand the concept of a ratio</p>
Critical Background Knowledge from Previous Grade Levels	
<ul style="list-style-type: none"> • Interpret products of whole numbers and whole-number quotients (3.OA.1, 3.OA.2) • Use multiplication and division within 100 to solve word problems in situations involving equal groups, arrays, and measurement quantities (3.OA.3) • Use addition and subtraction to two-step solve word problems comparing unknowns in all positions (2.OA.1) 	
Academic Vocabulary	
multiply, compare, multiplicative comparison, additive comparison, equation, array, factor, product	

Suggested Models				Suggested Strategies
	Unknown Product	Group Size Unknown <small>How many in each group?</small>	Number of Groups Unknown <small>How many groups?</small>	<ul style="list-style-type: none"> • Use bar models, number lines, equations, and context to represent multiplicative comparison • Use concrete models such as connecting cubes, Cuisinare Rods, etc.
Multiplicative Comparison	<p style="text-align: center;">$3 \times 6 = ?$</p>	<p style="text-align: center;">\$18</p> <p style="text-align: center;">$3 \times ? = 18$ $18 \div 3 = ?$</p>	<p style="text-align: center;">\$18</p> <p style="text-align: center;">$? \times 6 = 18$ $18 \div 6 = ?$</p>	
General	$a \times b = ?$	$a \times ? = p$, and $p \div a = ?$	$? \times b = p$, and $p \div b = ?$	

Use the four operations (addition, subtraction, multiplication, and division) with whole numbers to solve problems (Standards 4.OA.1–3).	
Standard 4.OA.2 Multiply or divide to solve word problems involving multiplicative comparison, <i>for example, by using drawings and equations with a symbol for the unknown number to represent the problem, distinguishing multiplicative comparison from additive comparison.</i>	
Concepts and Skills to Master	
<ul style="list-style-type: none"> Solve the following types of comparison multiplication and division situations <ul style="list-style-type: none"> Compare/Larger Unknown word problems (A blue hat costs \$3. A red hat costs 4 times as much as the blue hat. How much does the red hat cost?) Compare/Smaller Unknown word problems (A red hat costs \$12 and that is 4 times as much as a blue hat costs. How much does a blue hat cost?) Compare/Multiplier Unknown word problems (A red hat costs \$12 & a blue hat costs \$3. How many times as much does the red hat cost as the blue hat?) <p>Teacher Note: Fourth grade is the first time that students view multiplication as a comparison. In first and second grade, students work with additive comparisons. Third grade students understand multiplication as groups or arrays of objects. In fourth grade, these understanding extend to multiplication as a comparison. Multiplicative comparison situations are more complex than equal groups and arrays, and must be carefully distinguished from additive comparison problems. This standard should be taught with standard 4.OA.1.</p>	
Related Standards: Current Grade Level	Related Standards: Future Grade Levels
<p>4.OA.3 Solve multi-step word problems using whole numbers and having whole-number answers using the four operations</p> <p>4.OA.1 Interpret multiplication as comparison</p> <p>4.MD.1 Within a single system of measurement, express measurements in a larger unit in terms of a smaller unit</p> <p>4.NF.4 Apply and extend understanding of multiplication to multiply a fraction by a whole number</p> <p>4.NF.1 Extend understanding of fraction equivalence and ordering</p>	<p>5.NF.3 Interpret a fraction as division of the numerator by the denominator</p> <p>5.NF.4 Apply and extend previous understandings of multiplication and division to multiply a fraction or a whole number by a fraction</p> <p>5.NF.5 Interpret multiplication as scaling</p> <p>5.OA.2 Write and interpret numerical expressions</p> <p>5.NF.6 Extend previous understanding of multiplication and division to multiply and divide fractions</p> <p>6.RP.1 , 6.RP.2. Understand the concept of a ratio and solve ratio problems</p>
Critical Background Knowledge from Previous Grade Levels	
<ul style="list-style-type: none"> Interpret products of whole numbers and whole-number quotients (3.OA.1, 3.OA.2) Use addition and subtraction to word problems comparing with unknowns in all positions (2.OA.1) 	
Academic Vocabulary	
multiplicative comparison, additive comparison	
Suggested Strategies	
<ul style="list-style-type: none"> Use bar models, number lines, equations, and context to represent multiplicative comparison Use concrete models such as connecting cubes, Cuisinare Rods, etc. 	

Suggested Models

Tape diagram used to solve the Compare problem in Table 3

B is the cost of a blue hat in dollars

R is the cost of a red hat in dollars

\$6

$$3 \times B = R$$

\$6 \$6 \$6

$$3 \times \$6 = \$18$$

A tape diagram used to solve a Compare problem

A big penguin will eat 3 times as much fish as a small penguin. The big penguin will eat 420 grams of fish. All together, how much will the two penguins eat?

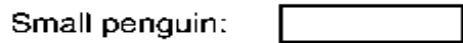
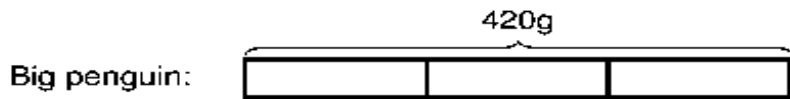

B = number of grams the big penguin eats
 S = number of grams the small penguin eats

$$3 \cdot S = B$$

$$3 \cdot S = 420$$

$$S = 140$$

$$S + B = 140 + 420 = 560$$

	Unknown Product	Group Size Unknown <small>How many in each group?</small>	Number of Groups Unknown <small>How many groups?</small>
Multiplicative Comparison	$3 \times 6 = ?$	<p>\$18</p> $3 \times ? = 18$ $18 \div 3 = ?$	<p>\$18</p> $? \times 6 = 18$ $18 \div 6 = ?$
General	$a \times b = ?$	$a \times ? = p$, and $p \div a = ?$	$? \times b = p$, and $p \div b = ?$

Use the four operations with whole numbers (addition, subtraction, multiplication, and division) to solve problems (Standards 4.OA.1–3).	
<p>Standard 4.OA.3 Solve multi-step word problems posed with whole numbers and having whole-number answers using the four operations, including problems in which remainders must be interpreted.</p> <p>a. Represent these problems using equations with a letter standing for the unknown quantity.</p> <p>b. Assess the reasonableness of answers using mental computation and estimation strategies, including rounding.</p>	
Concepts and Skills to Master	
<ul style="list-style-type: none"> • Differentiate between one-step and two-step word problems (Two-step word problems may include any combination of two operations in the same problem) • Determine the operation(s) based on the actions in the context of multi-step word problems (avoid relying on keyword strategies) • Use numbers and symbols to represent word problems (+, -, ×, ÷, =, and a letter for unknowns) • Know that multiplication and division are performed (in the order they appear in the problem; from left to right) prior to addition and subtraction (in the order they appear in the problem; from left to right) • Interpret remainders when necessary. • Determine the reasonableness of the calculated answer using mental computation and estimation strategies 	
Related Standards: Current Grade Levels	Related Standards: Future Grade Levels
<p>4.OA.2 Multiply and divide to solve word problems involving multiplicative comparisons</p> <p>4.OA.3 Solve multi-step word problems using whole numbers and having whole-number answers using the four operations</p> <p>4.NBT.3 Use place value understanding to round multi-digit whole numbers to any place</p> <p>4.NBT.4 Fluently add and subtract multi-digit whole numbers using the standard algorithm</p> <p>4.NBT.5 Multiply a whole number of up to four digits by a one-digit whole number, and multiply two two-digit numbers</p> <p>4.NBT.6 Find whole-number quotients and remainders with up to four-digit dividends and one-digit divisors, using strategies based on place value, the properties of operations, and/or the relationship between multiplication and division</p>	<p>5.NF.2 Solve real-world problems involving addition and subtraction of fractions referring to the same whole, including cases of unlike denominators. Use benchmark fractions and number sense of fractions to estimate mentally and assess the reasonableness of answers</p> <p>5.NF.6 Solve real-world problems involving multiplication of fractions and mixed numbers</p>
Critical Background Knowledge from Previous Grade Levels	
<ul style="list-style-type: none"> • Interpret products of whole numbers and whole-number quotients (3.OA.1, 3.OA.2) • Determine the unknown whole number in a multiplication or division equations (3.OA.4) • Apply properties of operations as strategies to multiply and divide (3.OA.5) • Understand the relationship between multiplication and division (3.OA.6) • Fluently multiply and divide (3.OA.7) • Represent & solve two-step problems using equations with a letter standing for the unknown (3.OA.8) • Use addition and subtraction within 100 to solve one-step and two-step problems (2.OA.2) 	
Academic Vocabulary	
multi-step word problem, mental math, estimation, rounding, remainder, variable, operations, equation, reasonableness, inverse operations, multiplicative comparison, additive comparison, symbol	



Suggested Models	Suggested Strategies
<p>A two-step problem with diagram showing problem situation and equations showing the two parts</p> <p>Carla has 4 packages of silly bands. Each package has 8 silly bands in it. Agustin is supposed to get 15 fewer silly bands than Carla. How many silly bands should Agustin get?</p> <p>Carla: </p> <p>Agustin: </p> <p>C = number of Carla's silly bands A = number of Agustin's silly bands</p> $C = 4 \times 8 = 32$ $A + 15 = C$ $A + 15 = 32$ $A = 17$ <p><i>Students may be able to solve this problem without writing such equations.</i></p>	<ul style="list-style-type: none">• Use drawings, objects, and equations• Use a bar model• Apply Part/Part/Whole• Create student-generated word problems• Skip count• Use the relationship between multiplication and division
Image Source: https://commoncoretools.files.wordpress.com/2011/05/ccss_progression_cc_oa_k5_2011_05_302.pdf	

TABLE 2. Common multiplication and division situations. ¹



	Unknown Product	Group Size Unknown <i>("How many in each group?" Division)</i>	Number of Groups Unknown <i>("How many groups?" Division)</i>
	$3 \times 6 = ?$	$3 \times ? = 18$ and $18 \div 3 = ?$	$? \times 6 = 18$ and $18 \div 6 = ?$
EQUAL GROUPS	There are 3 bags with 6 plums in each bag. How many plums are there in all? Measurement example. You need 3 lengths of string, each 6 inches long. How much string will you need altogether?	If 18 plums are shared equally into 3 bags, then how many plums will be in each bag? Measurement example. You have 18 inches of string, which you will cut into 3 equal pieces. How long will each piece of string be?	If 18 plums are to be packed 6 to a bag, then how many bags are needed? Measurement example. You have 18 inches of string, which you will cut into pieces that are 6 inches long. How many pieces of string will you have?
ARRAYS²	There are 3 rows of apples with 6 apples in each row. How many apples are there?	If 18 apples are arranged into 3 equal rows, how many apples will be in each row?	If 18 apples are arranged into equal rows of 6 apples, how many rows will there be?
AREA³	What is the area of a 3 cm by 6 cm rectangle?	A rectangle has area 18 square centimeters. If one side is 3 cm long, how long is a side next to it?	A rectangle has area 18 square centimeters. If one side is 6 cm long, how long is a side next to it?
COMPARE⁴	A blue hat costs \$6. A red hat costs 3 times as much as the blue hat. How much does the red hat cost? Measurement example. A rubber band is 6 cm long. How long will the rubber band be when it is stretched to be 3 times as long?	A red hat costs \$18 and that is 3 times as much as a blue hat costs. How much does a blue hat cost? Measurement example. A rubber band is stretched to be 18 cm long and that is 3 times as long as it was at first. How long was the rubber band at first?	A red hat costs \$18 and a blue hat costs \$6. How many times as much does the red hat cost as the blue hat? Measurement example. A rubber band was 6 cm long at first. Now it is stretched to be 18 cm long. How many times as long is the rubber band now as it was at first?
GENERAL	$a \times b = ?$	$a \times ? = p$ and $p \div a = ?$	$? \times b = p$ and $p \div b = ?$

¹ The first examples in each cell are examples of discrete things. These are easier for students and should be given before the measurement examples.

² The language in the array examples shows the easiest form of array problems. A harder form is to use the terms rows and columns: The apples in the grocery window are in 3 rows and 6 columns. How many apples are in there? Both forms are valuable.

³ Area involves arrays of squares that have been pushed together so that there are no gaps or overlaps, so array problems include these especially important measurement situations.

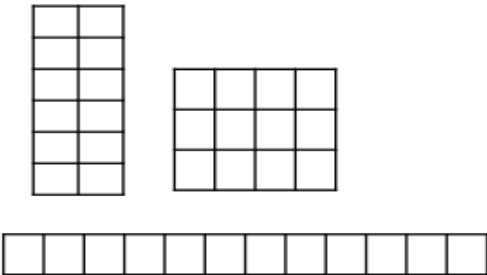
⁴ Multiplicative Compare problems appear first in Grade 4, with whole-number values in all places, and with the "times as much" language in the table. In Grade 5, unit fraction language such as "one third as much" may be used. Multiplying and unit fraction language change the subject of the comparing sentence, e.g., "A red hat costs A times as much as the blue hat" results in the same comparison as "A blue hat costs 1/A times as much as the red hat," but has a different subject.

Gain familiarity with factors and multiples (Standard 4.OA.4).	
Standard 4.OA.4 Find all factor pairs for a whole number in the range 1-100. Recognize that a whole number is a multiple of each of its factors. Determine whether a given whole number in the range 1-100 is a multiple of a given one-digit number. Determine whether a given whole number in the range 1-100 is prime or composite.	
Concepts and Skills to Master	
<ul style="list-style-type: none"> • Understand factor pairs as two whole numbers that multiply together to get one product • Understand that prime numbers have exactly one factor pair • Understand that composite numbers have more than one factor pair • Understand multiples as a product of two given whole numbers. • List the multiples of the numbers 2 through 9 up to 100 • Create a list or chart of factor pairs of whole numbers 1-100 • Identify, from a list or chart, which whole numbers are prime or composite <p>Teacher Note: The number 1 is neither prime nor composite. A prime number is a number greater than 1 that has only 2 factors, 1 and itself. Composite numbers have more than 2 factors.</p>	
Related Standards: Current Grade Level	Related Standards: Future Grade Levels
<p>4.NBT.5 Multiply a whole number of up to four digits by a one-digit whole number and multiply two two-digit numbers</p> <p>4.NBT.6 Find whole-number quotients with up to four-digit divisors and one-digit dividends</p>	6.NS.4 Find the greatest common factor and least common multiple of two whole numbers
Critical Background Knowledge from Previous Grade Levels	
<ul style="list-style-type: none"> • Determine unknown whole numbers in multiplication and division equations (3.OA.4) • Understand the relationship between multiplication and division (3.OA.6) • Fluently multiply and divide (3.OA.7) • Identify and explain arithmetic patterns in multiplication and addition tables (3.OA.9) 	
Academic Vocabulary	
factor, factor pairs, multiple, prime, composite, whole number	
Suggested Models	Suggest Strategies
<p>The number 12 can be made into several different rectangular arrays (1×12, 3×4, 6×2) and is therefore a composite number.</p> 	<p>The number 7 can only be made into one rectangular array and is therefore a prime number.</p> 
	<ul style="list-style-type: none"> • Use counters to build rectangular arrays • Use tools such as number lines, hundreds charts, arrays, or cubes to model relationships between factors and multiples

Generate and analyze numeric and shape patterns (Standard 4.OA.5).

Standard 4.OA.5 Generate a number or shape pattern that follows a given rule. Identify apparent features of the pattern that were not explicit in the rule itself. *For example, given the rule "add 3" and the starting number 1, generate terms in the resulting sequence and observe that the terms appear to alternate between odd and even numbers. Explain informally why the numbers will continue to alternate in this way.*

Concepts and Skills to Master

- Understand that number and shape patterns follow a given rule
- Understand that there are sometimes features of the pattern that are not stated in the rule
- Complete a given number or shape pattern (e.g., 3, 6, 9, __, __, 18)
- Determine the rule of a given pattern (e.g., 3, 6, 9, 12, 15, 18, ... The rule is to skip count by 3 or multiples of 3)
- Generate a number or shape pattern that follows a rule and state the rule
- Identify and state any alternate features of the pattern that are not stated in the rule
- Extend a given number or shape pattern using manipulatives, skip counting, pictures, etc.

Teacher Note: Although students find the given rule to a pattern, they are not required to use variables to explain or write the related expression. Emphasis should be placed on patterns with one-step; although, students may be exposed to patterns with two-steps.

Related Standards: Current Grade Level

4.OA.3 Solve multi-step word problems and represent these problems with equations that use variables

Related Standards: Future Grade Levels

5.OA.3 Generate two numerical patterns using two given rules, identify relationships between corresponding terms, and form ordered pairs for graphing on a coordinate plane
6.EE.2 Write, read, and evaluate expressions in which letters represent numbers
6.EE.9 Use variables to represent two quantities that change in relationship to one another and write expressions to express one quantity in terms of the other quantity
6.RP.1 Understand the concept of a ratio and use ratio language to describe a relationship between two quantities

Critical Background Knowledge from Previous Grade Levels

- Identify and explain arithmetic patterns (3.OA.9)
- Determine whether a group of objects (up to 20) has an odd or even number of members (2.OA.3)

Academic Vocabulary

number pattern, shape pattern, pattern rule, sequence, input/output table

Suggested Models

1	2	3	4	5	6	7	8	9	10
11	12	13	14	15	16	17	18	19	20
21	22	23	24	25	26	27	28	29	30
31	32	33	34	35	36	37	38	39	40
41	42	43	44	45	46	47	48	49	50
51	52	53	54	55	56	57	58	59	60
61	62	63	64	65	66	67	68	69	70
71	72	73	74	75	76	77	78	79	80
81	82	83	84	85	86	87	88	89	90
91	92	93	94	95	96	97	98	99	100

What is the rule of the pattern?
Start at 4 and add 3

What do you notice about this pattern?
even, odd, even, odd, even, odd, ...
It looks like stairs with two white steps in between

Write a context or story to match this pattern.
It costs \$4 to play a game and \$3 for each additional game

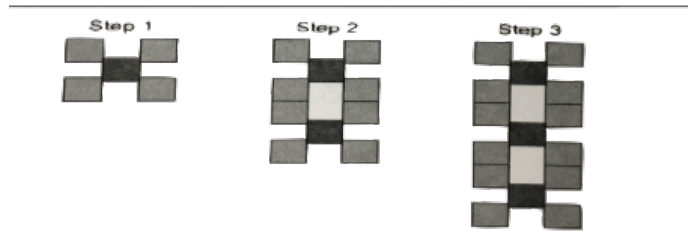

(a) Pattern blocks

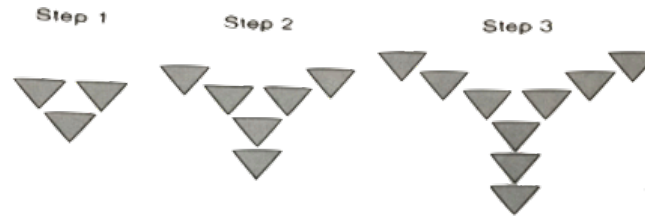

(b) Color tiles

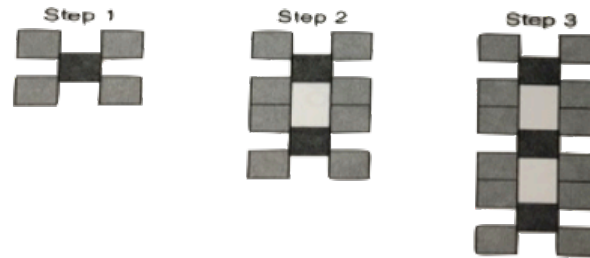

Suggested Strategies

- Create and describe patterns in number charts
- Create and describe patterns using pattern blocks, colored tiles, cubes paper squares, etc.
- Create and work with tables
- Use input-output tables
- Write sequences forwards and backwards
- Predict terms that come later in given patterns

Generalize place value understanding for multi-digit whole numbers by analyzing patterns, writing whole numbers in a variety of ways, making comparisons, and rounding (Standards 4.NBT.1–3)

Standard 4.NBT.1 Recognize that in a multi-digit whole number, a digit in one place represents ten times what it represents in the place to its right. *For example, recognize that $700 \div 70 = 10$ by applying concepts of place value and division.*

Concepts and Skills to Master

- Understand the places of numbers and the value of each place
- Model place and value relationships showing how a digit in one place represents ten times what it represents in the place to its right (Use manipulatives such as place value blocks, mats, discs, etc.)
- Understand that the value of each place is ten times greater than the place to the right
- Understand that the value of each place is ten times less than the place to the left
- Multiply and divide numbers by multiples of tens, hundreds, thousands, etc. to one million (For example: $70 \times 100 = 7,000$ $5,000 \times 10 = 50,000$ and $700 \div 70 = 10$ $50,000 \div 50 = 1,000$)

Teacher Note: This standard is a prerequisite to 5.NBT.1 and 5.NBT.2, where students will describe the shifting of digits when multiplying and dividing numbers by multiples of ten.

Related Standards: Current Grade Level

- 4.OA.1–2** Interpret a multiplication equation as a comparison
- 4.NBT.2** Read and write multi-digit whole numbers using base-ten numerals, number names, and expanded form
- 4.NBT.3** Use place value understanding to round multi-digit whole numbers to any place
- 4.NBT.4** Fluently add and subtract multi-digit whole numbers
- 4.NBT.5** Multiply a whole number up to four digits by a one-digit whole number, and multiply two two-digit numbers using strategies based on place value
- 4.NBT.6** Find whole-number quotients and remainders with up to four-digit dividends and one-digit divisors, using strategies based on place value

Related Standards: Future Grade Levels

- 5.NBT.1** Recognize that in a multi-digit number, a digit in one place represent 10 times as much as it represents in the place to its right and 1/10 of what it represents in the place to its left.
- 5.NBT.2** Explain patterns in the numbers of zeros of the product when multiplying a number by powers of 10

Critical Background Knowledge from Previous Grade Levels

- Multiply one-digit whole numbers by multiples of ten (3.NBT.3)
- Represent and solve problems involving multiplication and division within 100 (3.OA.1–4, 7)
- Understand the relationship between multiplication and division and fluently multiply and divide within 100 (3.OA.5–6)
- Understand that the three digits of a three-digit number represent amounts of hundreds, tens, and ones (2.NBT.1)

Academic Vocabulary

inverse operation, base ten numeral (standard form), value, place, and place value, digit, multiply, divide

Suggested Models | Suggested Strategies

Each digit in the number 78 becomes one hundred times as much as its original value. The 8 ones becomes 8 hundreds. The 7 tens becomes 7 thousands.

Thousands	Hundreds	Tens	Ones
		7	8
7	8	0	0

Note: In the original image, arrows point from the 7 in the Tens place to the 7 in the Thousands place, and from the 8 in the Ones place to the 8 in the Hundreds place. A multiplier 'x100' is shown below the 8 in the Ones place.

- Explore patterns that involve moving digits to different places in a given numeral
- Investigate patterns associated with the answers obtained to problems such as the following:

7×10
 7×100
 $7 \times 1,000$
 $7 \times 10,000$

Relate the findings to patterns on the place value chart and using concrete models as shown below.

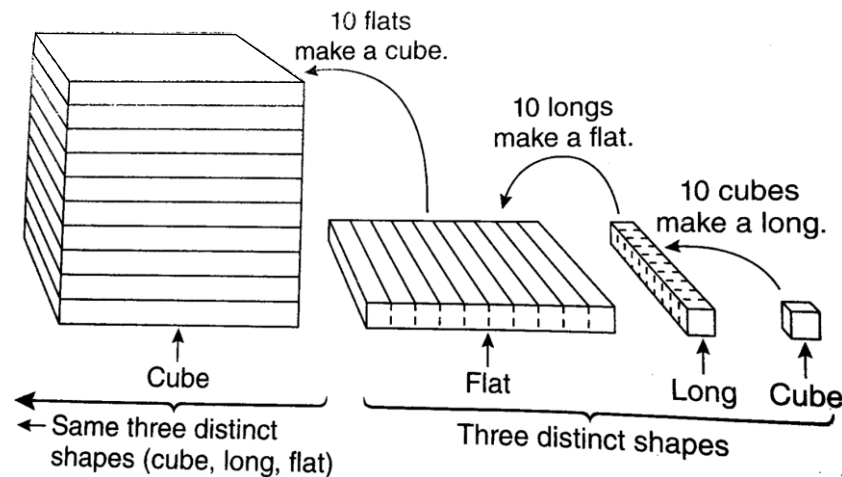

With every three places, the shapes repeat.

Image Source: A., V. D., Karp, K. S., Lovin, L. H., & Bay-Williams, J. M. (2014). *Teaching student-centered mathematics* Grades 3-5. Boston: Pearson.

Generalize place value understanding for multi-digit whole numbers by analyzing patterns, writing whole numbers in a variety of ways, making comparisons, and rounding (Standards 4.NBT.1–3)

Standard 4.NBT.2 Read and write multi-digit whole numbers using base-ten numerals, number names, and expanded form. Compare two multi-digit numbers based on meanings of the digits in each place, using $>$, $=$, and $<$ symbols to record the results of comparisons.

Concepts and Skills to Master

- Express a given number in multiple ways:
 - base-ten numerals (42,371)
 - base-ten word form (4 ten thousands, 2 thousands, 3 hundreds, 7 tens, and 1 one)
 - number names (forty-two thousand, three hundred seventy-one)
 - expanded form ($40,000 + 2,000 + 300 + 70 + 1$)
- Understand that when comparing two numbers, one looks at the whole number, not just individual digits
- Understand the role of commas when reading a whole number
- Understand that a number (greater than 0) in the thousands place always has a greater value than the number in the hundreds place
- Line up numbers by place value and describe the place value of each digit to compare the numbers
- Understand that if the number of thousands is the same, the number with more hundreds is greater. If the number of thousands and hundreds is the same, the number with more tens is greater
- Use terms including greater than, more than, less than, fewer than, equal to, and same as, to describe comparisons
- Use the symbols $>$, $=$, and $<$ to correctly compare multi-digit numbers

Teacher Notes: Emphasis should be placed on the meaning of quantities rather than tricks such as “the alligator eats the bigger number.” The inequality symbols ($<$, $>$) are shortcuts for identifying the relationship between two numbers where one is greater or smaller than the other. The statements are read from left to right (for example, $15,000 < 28,000$ is read fifteen thousand is less than twenty-eight thousand).

Related Standards: Current Grade Level	Related Standards: Future Grade Levels
<p>4.NBT.1 Recognize that in a multi-digit whole number, a digit in one place represents ten times what it represents in the place to its right.</p> <p>4.NF.7 Compare two decimals to hundredths by reasoning about their size. Record the results of comparisons with the symbols $>$, $<$, or $=$ and justify the conclusions.</p>	<p>5.NBT.3 Read, write, and compare decimals to thousandths.</p> <p>6.NS.7 Understand ordering and absolute value of rational numbers. Interpret statements of inequality as statements about the relative position of two numbers on a number line diagram.</p> <p>6.EE.8 Write an inequality of the form $x > c$ or $x < c$</p>

Critical Background Knowledge from Previous Grade Levels

- Compare two fractions with the same numerator or the same denominator. Record the results of comparisons with the symbols $>$, $+$, or $<$ (3.NF.3)
- Read and write numbers to 1,000 using base-ten numerals, number names and expanded form (2.NBT.3)
- Compare two three-digit numbers based on meanings of the hundreds, tens, and ones digits, using $>$, $=$, and $<$ symbols to record the results of comparisons. (2.NBT.4)
- Understand that the three digits of a three-digit number represent amounts of hundreds, tens, and ones (2.NBT.1)

Academic Vocabulary

base-ten numeral (formally known as standard form), number names (formally known as word form), expanded form, compare, more, fewer, greater than ($>$), less than ($<$), equal to ($=$), same as

Suggested Strategies

- Use concrete materials such as objects on a place value chart, base-ten blocks, and number lines to compare two multi-digit numbers

Suggested Models

Compare 4,023,135 and 4,023,235 using a place value chart.

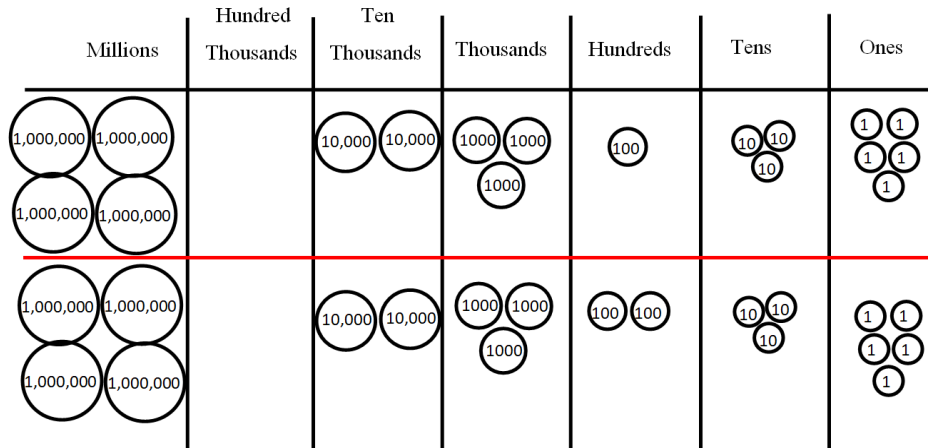

Each digit in the million spot has a value of 4,000,000. Each digit in the hundred thousand spot has a value of 0. Each digit in the ten thousand spot has a value of 20,000. Each digit in the thousand spot has a value of 3,000. One digit in the hundred spot has a value of 100 and the other has a value of 200.

Since 200 is a greater value than 100, that number has a larger value. So, 4,023,135 is less than 4,023,235. Or $4,023,135 < 4,023,235$.

Compare 7,975 and 7,925 using a double number line.

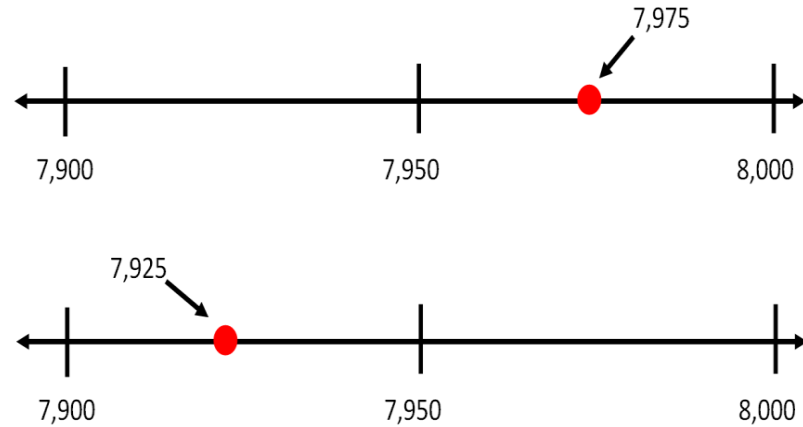

7,925 is closer to the left of the number line than 7,975. So 7,975 is greater than 7,925. Or $7,975 > 7,925$.

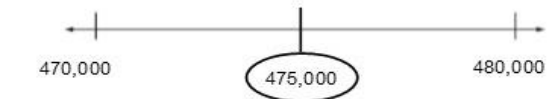
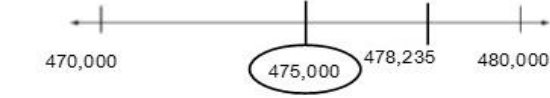
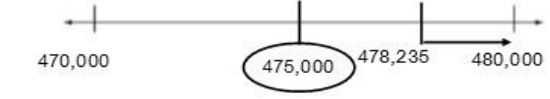
<p>Generalize place value understanding for multi-digit whole numbers by analyzing patterns, writing whole numbers in a variety of ways, making comparisons, and rounding (Standards 4.NBT.1–3)</p>	
<p>Standard 4.NBT.3 Use place value understanding to round multi-digit whole numbers to any place.</p>	
<p>Concepts and Skills to Master</p> <ul style="list-style-type: none"> • Use place value understanding to round whole numbers less than or equal to 1,000,000 • Understand that rounding can be applied to any place within a number • Understand when rounding to the nearest tens, hundreds, thousands, ten-thousands, hundred-thousands, or millions place, the goal is to approximate the closest number with zero units in the places to the right of the digit to be rounded to (For example, 478,235 rounded to the nearest ten-thousand is 480,000; and 478,235 rounded to the nearest hundred-thousand is 500,000) • Connect rounding numbers to the location of the number on a number line by identifying the benchmark numbers and using the midpoint to determine which benchmark number is closer (For example, when rounding 478,235 to the nearest ten-thousand, the benchmark numbers are 470,000 and 480,000, the midpoint is 475,000. The number 478,235 is to the right of the midpoint and closer to 480,000 than 470,000. The number 478,235 is therefore rounded to 480,000. See the model below) <p>Teacher Note: Rounding to the unit represented by the place farthest to the left is typically easier for students and often sufficient for practical purposes. Rounding to the unit represented by a place in the middle of a number may be more difficult for students as the surrounding digits can be distracting. For example, it may be easier for a student to round 478,235 to 500,000 rather than to 480,000. Students should have experience rounding multi-digit numbers to various places.</p>	
<p>Related Standards: Current Course</p> <p>4.NBT.1 Recognize that in a multi-digit whole number, a digit in one place represents ten times what it represents in the place to its right</p> <p>4.OA.3 Solve multi-step word problems and assess the reasonableness of answers using mental computation and estimation strategies including rounding</p>	<p>Related Standards: Future Courses</p> <p>5.NBT.4 Use place value understanding to round decimals to hundredths</p>
<p>Critical Background Knowledge from Previous Grade Levels</p> <ul style="list-style-type: none"> • Use place value understanding to round two-digit and three-digit numbers to the nearest 10 and 100 (3.NBT.1) • Read and write numbers to 1,000 using base-ten numerals, number names, and expanded form (2.NBT.3) • Understand that the three-digits of a three-digit number represent amounts of hundreds, tens, and ones. Understand the value of each digit in three-digit numbers (2.NBT.1) 	<p>Suggested Model</p> <p>Example: Round 478,235 to the nearest ten thousands.</p> <p>Step One:</p>  <p>Step Two:</p>  <p>Step Three:</p>  <p>Step Four:</p> 
<p>Academic Vocabulary</p> <p>round, benchmark number, midpoint, digit, estimate, close to, nearest place, tens place, hundreds place, thousands place, ten-thousands place, hundred-thousands place, millions place</p>	
<p>Suggested Strategies</p> <ul style="list-style-type: none"> • Create and use horizontal and vertical open number lines to identify, locate, and label benchmark numbers, midpoints, and target numbers to assist in rounding • Use base-ten blocks to model rounding up to the thousands place • Use a place value chart and/or place value disks as a tool for support when rounding • While songs and mnemonic stories may be engaging, they should not be used in place of developing conceptual understanding of rounding. If these are to be used, they should come after conceptual understanding has been developed • Use drawings to model the concept of rounding 	

Use place value understanding and properties of operations to perform multi digit addition, subtraction, multiplication, and division using a one-digit divisor (Standards 4.NBT.4–6)

Standard 4.NBT.4 Fluently add and subtract multi-digit whole numbers using the standard algorithm.

Concepts and Skills to Master

- Extend understanding of addition and subtraction of multi-digit whole numbers
- Fluently compute sums and differences of whole numbers using a variety of strategies including the standard algorithm
- Use properties of operation and place value to explain the standard algorithm
- Build understanding and explain connections between various addition and subtraction strategies and the standard algorithm

Teacher Note: The standard algorithms of addition and subtraction are neither an expectation nor a focus in second grade. Students use multiple strategies for addition and subtraction in grades K-3. By the end of third grade students use a range of algorithms based on place value, properties of operations, and/or the relationships between addition and subtraction to add and subtract multi-digit whole numbers. Students are expected to fluently add and subtract multi-digit whole numbers using the standard algorithm by the end of fourth grade. Fourth grade students should not only focus on the standard algorithm, but should progress from strategies used in grades K-3 to the standard algorithm. “The standards define a computation algorithm as a set of predefined steps applicable to a class of problems that gives the correct result in every case when the steps are carried out correctly. In mathematics, an algorithm is defined by its steps and not by the way those steps are recorded in writing. The Standards do not specify a particular standard algorithm for each operation.” http://commoncoretools.me/wp-content/uploads/2015/03/ccss_progression_nbp_k5_2015_03_16.pdf

Related Standards: Current Grade Level

4.NBT.1 Recognize that in a multi-digit whole number, a digit in one place represents ten times what it represents in the place to its right

Related Standards: Future Grade Levels

5.NBT.5 Fluently multiply multi-digit whole numbers using the standard algorithm
5.NBT.6 Find quotients of whole numbers with up to four-digit dividends and two-digit divisors, using strategies
5.NBT.7 Add, subtract, multiply, and divide decimals to hundredths, using concrete models or drawings and strategies
6.NS.3 Fluently add, subtract, multiply, and divide multi-digit decimals using the standard algorithm

Critical Background Knowledge from Previous Grade Levels

- Fluently add and subtract within 1000 using strategies and algorithms based on place value, properties of operations, and/or the relationship between addition and subtraction (3.NBT.2)
- Fluently add and subtract within 100 using strategies based on place value, properties of operations, and/or the relationship between addition and subtraction (2.NBT.5)
- Add and subtract within 1,000 using concrete models or drawings (2.NBT.7)

Suggested Models

Place Value Blocks

Compensation

Academic Vocabulary

sum, difference, total, addends

Suggested Strategies

- Use base ten models and connect the model to the algorithm
- Connect standard algorithms to strategies for addition and subtraction

Image Source: DSD Advantage Math 4.NBT

Use place value understanding and properties of operations to perform multi digit addition, subtraction, multiplication, and division using a one-digit divisor (Standards 4.NBT.4–6)

Standard 4.NBT.5 Multiply a whole number of up to four digits by a one-digit whole number, and multiply two two-digit numbers, using strategies based on place value and the properties of operations. Illustrate and explain the calculation by using equations, rectangular arrays, and/or area models.

Concepts and Skills to Master

- Extend understanding of multiplication with one-digit numbers to multiply specified multi-digit numbers
- Understand how to compute products of one-digit numbers and multiples of 10, 100, and 1,000
- Use the distributive property to decompose numbers into multiples of 10, 100, and 1,000 and multiply those multiples by one-digit numbers to solve for products
- Explain the pattern when multiplying by a value of 10, 100, or 1,000
- Demonstrate understanding of the relationships between pictures and/or equations representing multiplying whole numbers
- Use a variety of strategies to multiply the following numbers:
 - one-digit number by a one-digit number
 - one-digit number by a two-digit number
 - one-digit number by a three-digit number
 - one-digit number by a four-digit number
 - two-digit number by a two-digit number



Teacher Note: A standard algorithm of multiplication is neither an expectation nor a focus in fourth grade. Students use multiple strategies for multiplication in grades 3-5. By the end of fourth grade students use a range of algorithms based on place value, properties of operations, and/or the relationships between addition and multiplication to multiply multi-digit whole numbers. Students are expected to fluently multiply multi-digit whole numbers using a standard algorithm by the end of fifth grade.

Related Standards: Current Grade Level

4.OA.2 Multiply or divide to solve word problems involving multiplicative comparison
4.OA.3 Solve multi-step word problems posed with whole numbers and having whole-number answers using multiplication
4.OA.4 Find factor pairs and recognize multiples
4.NBT.1 Recognize that in a multi-digit whole number, a digit in one place represents ten times what it represents in the place to its right
4.NBT.6 Find whole-number quotients and remainders with up to four-digit dividends and one-digit divisors
4.MD.2 Use the four operations to solve measurement word problems
4.MD.3 Apply the area and perimeter formulas for rectangles in real-world and mathematical problems

Related Standards: Future Grade Levels

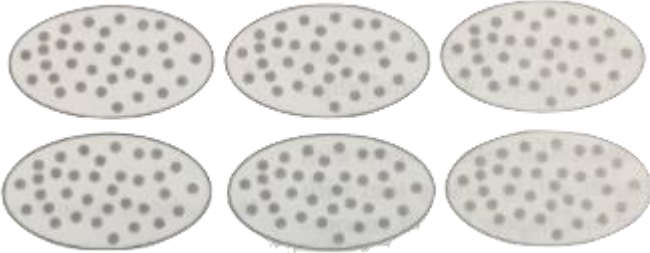
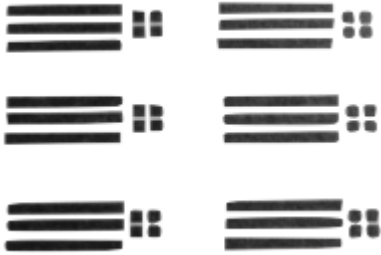
5.NBT.2 Explain patterns in the number of zeros of the product when multiplying a number by powers of 10
5.NBT.5 Fluently multiply multi-digit whole numbers using the standard algorithm
5.NBT.7 Multiply decimals to hundredths, using concrete models or drawings and strategies based on place value
5.NF.4 Apply and extend previous understandings of multiplication to multiply a fraction or whole number by a fraction (using area models and partial products)
6.NS.3 Fluently multiply multi-digit decimals using the standard algorithm

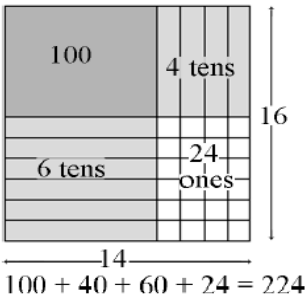
<p>Critical Background Knowledge from Previous Grade Levels</p> <ul style="list-style-type: none"> • Interpret the products of whole numbers, such as interpreting 5×7 as the total number of objects in 5 groups of 7 objects each (3.OA.1) • Use multiplication and division within 100 to solve word problems in situations involving equal groups, arrays, and measurement quantities (3.OA.3) • Determine the unknown whole number in a multiplication or division equation relating three whole numbers (3.OA.4) • Apply properties of operations as strategies to multiply and divide (3.OA.5) • Fluently multiply and divide within 100, using strategies such as the relationship between multiplication and division or properties of operations. By the end of third grade, know from memory all products of two one-digit numbers (3.OA.7) • Multiply one-digit whole numbers by multiples of 10 in the range 10–90, for example, 9×80 and 5×60 (3.NBT.3) • Relate area to the operations of multiplication and addition (3.MD.7) • Use addition to find the total number of objects arranged in rectangular arrays. Partition a rectangle into rows and column of same-sized squares and count to find the total number of squares (2.OA.4, 2.G.2) 	
<p>Academic Vocabulary</p> <p>equal groups, array, area model, multiply, factor, product, factor pairs, multiples, distributive property, partial products, multiples of 10, 100, and 1,000</p>	
<p>Suggested Strategies</p> <ul style="list-style-type: none"> • Use objects (base-ten blocks or place-value discs) and drawings (equal groups, arrays, and area models) to represent multiplication • Write partial product equations to represent arrays and area models; Explain connections between physical/visual models and equations • Use the distributive property to solve multiplication problems • Apply the commutative or associative properties of multiplication 	
<p>Suggested Models</p> <p>Teacher Note: These models are ordered in a progression from most concrete to more abstract and more efficient. While it may be acceptable to begin with individual objects to connect to third grade strategies, students should progress towards more efficient strategies.</p>	
<p>Equal groups with groupable objects for $6 \times 34 = 204$:</p> $34 + 34 + 34 + 34 + 34 + 34 = 204$ 	<p>Equal groups with pre-grouped base-ten objects for $6 \times 34 = 204$:</p> $34 + 34 + 34 + 34 + 34 + 34 = 204$ 
<p>Array with base-ten blocks for $6 \times 34 = 204$:</p> 	<p>Area model with base-ten blocks or graph paper for $16 \times 14 = 224$:</p> 

Area model for $6 \times 3,253$:

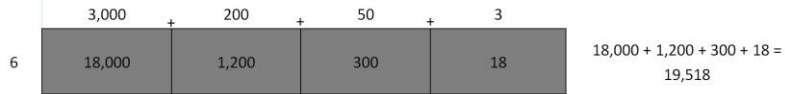

Area model for 25×15 :

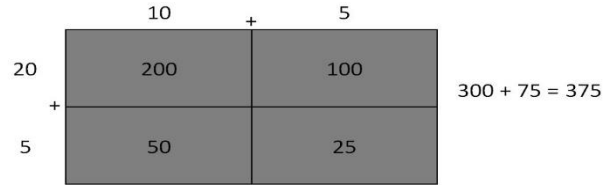

Partial products for 25×15 :

$$\begin{array}{r}
 25 \\
 \times 15 \\
 \hline
 125 \quad (5 \times 25) \\
 375 \quad (20 \times 25) \\
 \hline
 375
 \end{array}$$

Distributive Property for 8×347 :

$$\begin{aligned}
 &(300 \times 8) + (40 \times 8) + (7 \times 8) = \\
 &2,400 + 320 + 56 = 2,776
 \end{aligned}$$

Distributive Property for 25×15 :

$$\begin{aligned}
 &(20 \times 10) + (5 \times 10) + (20 \times 5) + (5 \times 5) = \\
 &200 + 50 + 100 + 25 = 375
 \end{aligned}$$

Partial products for 8×347 :

$$\begin{array}{r}
 347 \\
 \times 8 \\
 \hline
 2,800 \quad (300 \times 8) \\
 320 \quad (40 \times 8) \\
 + 56 \quad (7 \times 8) \\
 \hline
 2,776
 \end{array}$$

Image Source: Van de Walle, John A. (2014). Teaching student-centered mathematics. Developmentally appropriate instruction for grades 3-5. Boston :Pearson pp.180

Use place value understanding and properties of operations to perform multi digit addition, subtraction, multiplication, and division using a one-digit divisor (Standards 4.NBT.4–6)	
Standard 4.NBT.6 Find whole-number quotients and remainders with up to four-digit dividends and one-digit divisors, using strategies based on place value, the properties of operations, and/or the relationship between multiplication and division. Illustrate and explain the calculation by using equations, rectangular arrays, and/or area models.	
Concepts and Skills to Master	
<ul style="list-style-type: none"> • Extend understanding of division within 100 to divide specified multi-digit numbers by one-digit divisors • Use a variety of strategies to find quotients between the following numbers with and without remainders: <ul style="list-style-type: none"> ○ one-digit divisors and one-digit dividends ○ one-digit divisors and two-digit dividends ○ one-digit divisors and three-digit dividends ○ one-digit divisors and four-digit dividends • Compute quotients in a variety of situations, including with zeros in various places • Interpret whole-number quotients of whole numbers with and without remainders from partitive and quotative contexts (Partitive: interpret $560 \div 8$ as the number of objects in each share when 560 objects are partitioned equally into eight shares; Quotative: interpret $560 \div 8$ as a number of shares when 560 objects are partitioned into equal shares of eight objects each) • Demonstrate understanding of the relationships between concrete models, pictures, and/or equations • Understand remainders as the quantity remaining when the divisor does not divide equally into the dividend • Interpret remainders in relation to standard 4.OA.3 <p>Teacher Note: A standard algorithm of division is neither an expectation nor a focus in fourth grade. There is not just one standard algorithm and students should use multiple strategies for division in grades 3-5. By the end of fourth grade students use a range of algorithms based on place value, properties of operations, and/or the relationships between subtraction and division to divide multi-digit whole numbers. Students are expected to fluently divide multi-digit whole numbers using a standard algorithm by the end of sixth grade.</p>	
Related Standards: Current Course	Related Standards: Future Courses
<p>4.OA.2 Multiply or divide to solve word problems involving multiplicative comparison</p> <p>4.OA.3 Solve multi-step word problems posed with whole numbers using the four operations, including problems in which remainders must be interpreted</p> <p>4.OA.4 Find factor pairs and recognize multiples</p> <p>4.NBT.1 Recognize that in a multi-digit whole number, a digit in one place represents ten times what it represents in the place to its right</p> <p>4.MD.2 Use the four operations to solve measurement word problems</p>	<p>5.NBT.6 Find whole-number quotients of whole numbers with up to four-digit dividends and two-digit divisors</p> <p>5.NBT.7 Divide decimals to hundredths</p> <p>5.NF.3 Interpret a fraction as division of the numerator by the denominator</p> <p>6.NS.2 Fluently divide multi-digit numbers using the standard algorithm</p> <p>6.NS.3 Fluently divide multi-digit decimals using the standard algorithm</p>



Critical Background Knowledge from Previous Grade Levels

- Interpret whole-number quotients of whole numbers. For example, interpret $56 \div 8$ as the number of objects in each share when 56 objects are partitioned equally into eight shares (partitive), or as a number of shares when 56 objects are partitioned into equal shares of eight objects each (quotative) (3.OA.2)
- Use multiplication and division within 100 to solve word problems in situations involving equal groups, arrays, and measurement quantities (3.OA.3)
- Determine the unknown whole number in a multiplication or division equation relating three whole numbers (3.OA.4)
- Apply properties of operations as strategies to multiply and divide (3.OA.5)
- Understand division as an unknown-factor problem. Understand the relationship between multiplication and division (multiplication and division are inverse operations). For example, find $32 \div 8$ by finding the number that makes 32 when multiplied by 8 (3.OA.6)
- Fluently multiply and divide within 100, using strategies such as the relationship between multiplication and division or properties of operations. By the end of third grade, know from memory all products of two one-digit numbers (3.OA.7)
- Multiply one-digit whole numbers by multiples of 10 in the range 10–90, for example, 9×80 and 5×60 (3.NBT.3)
- Use addition to find the total number of objects arranged in rectangular arrays. Partition a rectangle into rows and columns of same-sized squares and count to find the total number of squares (2.OA.4, 2.G.2)

Academic Vocabulary

dividend, divisor, quotient, equal groups, partial quotients, remainder, place value

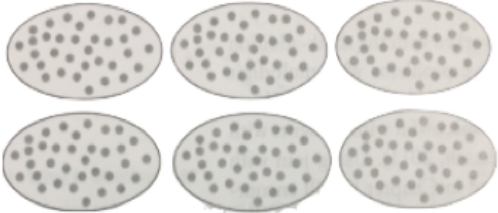
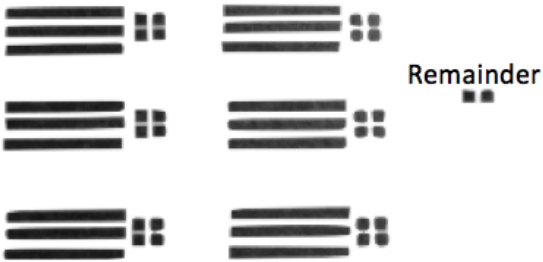
Suggested Models

<p>Equal groups with individual objects for $206 \div 6 = 34 R 2$</p>  <p>Remainder $\bullet\bullet$</p>	<p>Equal groups with base-ten objects for $206 \div 6 = 34 R 2$</p>  <p>Remainder $\bullet\bullet$</p>	<p>Connect multiplication to division, area model for $204 \div 6 = 34$</p> <table border="1" style="margin-left: auto; margin-right: auto;"> <tr> <td></td> <td style="text-align: center;">30</td> <td style="text-align: center;">+</td> <td style="text-align: center;">3</td> <td style="text-align: center;">+</td> <td style="text-align: center;">1</td> </tr> <tr> <td style="text-align: right;">6</td> <td style="text-align: center;">200</td> <td></td> <td style="text-align: center;">0+20</td> <td></td> <td style="text-align: center;">4+2=6</td> </tr> <tr> <td></td> <td style="text-align: center;">-180</td> <td></td> <td style="text-align: center;">-18</td> <td></td> <td style="text-align: center;">-6</td> </tr> <tr> <td></td> <td style="text-align: center;">20</td> <td></td> <td style="text-align: center;">2</td> <td></td> <td style="text-align: center;">0</td> </tr> </table> <p style="text-align: center;">204 \div 6 = <u>34</u></p>		30	+	3	+	1	6	200		0+20		4+2=6		-180		-18		-6		20		2		0
	30	+	3	+	1																					
6	200		0+20		4+2=6																					
	-180		-18		-6																					
	20		2		0																					
<p>Connect multiplication to division, area model for $204 \div 6 = 34$</p> <table style="margin-left: auto; margin-right: auto;"> <tr> <td></td> <td style="text-align: center;">30</td> <td style="text-align: center;">+</td> <td style="text-align: center;">4</td> </tr> <tr> <td style="text-align: right;">6</td> <td style="text-align: center;">180</td> <td></td> <td style="text-align: center;">24</td> </tr> </table> <p style="text-align: center;">180 + 24 = 204</p>			30	+	4	6	180		24	<p>Array with base-ten blocks for $204 \div 6 = 34$</p> 																
	30	+	4																							
6	180		24																							

How many groups of 5 are in 672? (At least 100)
 Use 100 as the first partial quotient. $100 \times 5 = 500$
 Subtract $672 - 500 = 172$

How many groups of 5 are in 172? (At least 20)
 Use 20 as the second partial quotient. $20 \times 5 = 100$
 Subtract $172 - 100 = 72$

How many groups of 5 are in 72? (At least 10)
 Use 10 as the third partial quotient. $10 \times 5 = 50$
 Subtract $72 - 50 = 22$

How many groups of 5 are in 22? (At least 4)
 Use 4 as the fourth partial quotient. $4 \times 5 = 20$
 Subtract $22 - 20 = 2$

Add the partial quotients and record any remainders.
 $100 + 20 + 10 + 4 = 134$
 Answer: 134 R2

$$\begin{array}{r}
 5 \overline{)672} \\
 \underline{500} \quad 100 \\
 172 \\
 \underline{100} \quad 20 \\
 72 \\
 \underline{50} \quad 10 \\
 22 \\
 \underline{20} \quad 4 \\
 \textcircled{2} \quad 134 \text{ R}2
 \end{array}$$

$$\begin{array}{r}
 5 \overline{)672} \\
 \underline{100} \quad 20 \\
 572 \\
 \underline{100} \quad 20 \\
 472 \\
 \underline{200} \quad 40 \\
 272 \\
 \underline{200} \quad 40 \\
 72 \\
 \underline{50} \quad 10 \\
 22 \\
 \underline{20} \quad 4 \\
 \textcircled{2} \quad 134 \text{ R}2
 \end{array}$$

Suggested Strategies

- Use the relationship between multiplication and division
- Use repeated subtraction and sharing as division strategies
- Use manipulatives such as base-ten blocks or place-value discs and drawings such as equal groups, arrays, and area models to represent division
- Use area models and partial quotients to model, explain, and visualize division
- Explain connections between concrete models, pictures, and/or equations

Images Source: Van de Walle, John A. (2014). Teaching student-centered mathematics. Developmentally appropriate instruction for grades 3-5. Boston :Pearson pp.180, 189, 190

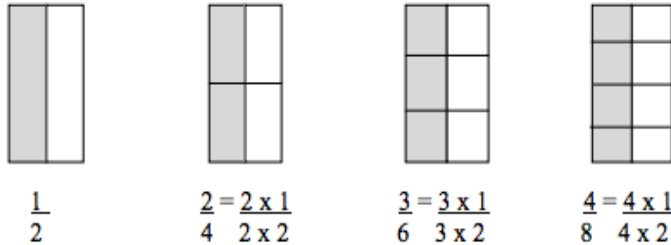
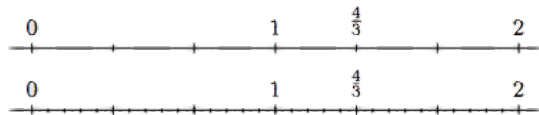
Extend understanding of equivalence and ordering of fractions (Standards 4.NF.1–2). Denominators for fourth grade are limited to 2, 3, 4, 5, 6, 8, 10, 12, and 100.	
Standard 4.NF.1 Explain why a fraction a/b is equivalent to a fraction $(n \times a)/(n \times b)$ by using visual fraction models, with attention to how the number and size of the parts differ even though the two fractions themselves are the same size. Use this principle to recognize and generate equivalent fractions.	
Concepts and Skills to Master	
<ul style="list-style-type: none"> Understand equivalent fractions as the same quantity with different names based on the number and size of the parts Recognize and explain how multiplying the numerator and denominator of a fraction by the same number, n, corresponds physically to partitioning each unit fraction piece into n smaller equal pieces (see model below) Explain how the principle of the multiplicative identity property of 1 transforms a fraction into an equivalent fraction and generate equivalent fractions using this principle (Students may, but need not, use the formal term for this property) 	
Teacher Note: Limit denominators to 2, 3, 4, 5, 6, 8, 10, 12, and 100.	
Related Standards: Current Grade Level	Related Standards: Future Grade Levels
4.NF.2 Compare and order fractions by generating equivalent fractions 4.NF.3c Replace mixed numbers with equivalent fractions 4.NF.5 Express a fraction with denominator 10 as an equivalent fraction with denominator 100	5.NF.1 and 2 Add and subtract with unlike denominators 5.NF.3 Interpret a fraction as division of the numerator by the denominator. 5.NF.5b Relate the principle of fraction equivalence 6.RP.3 Generate equivalent ratios and compare ratios
Critical Background Knowledge from Previous Grade Levels	
<ul style="list-style-type: none"> Represent whole numbers as equivalent fractions ($3/3 = 1$ and $4/1 = 4$) (3.NF.3) Understand equivalent fractions as the same quantity with different names (3.NF.3) Denominators are limited to 2, 3, 4, 6, and 8 in third grade 	
Academic Vocabulary	
Fraction, equivalent fraction, numerator, denominator, Denominators new to fourth grade: fifths ($1/5$), tenths ($1/10$), twelfths ($1/12$), hundredths ($1/100$)	
Suggested Models	Suggested Strategies
Visual models may include: area of various shapes (circles, rectangles, etc.), bar models, number lines, and double number lines  <div style="display: flex; justify-content: space-around; margin-top: 10px;"> <div style="text-align: center;">$\frac{1}{2}$</div> <div style="text-align: center;">$\frac{2}{4} = \frac{2 \times 1}{2 \times 2}$</div> <div style="text-align: center;">$\frac{3}{6} = \frac{3 \times 1}{3 \times 2}$</div> <div style="text-align: center;">$\frac{4}{8} = \frac{4 \times 1}{4 \times 2}$</div> </div> <div style="margin-top: 20px;"> <p style="text-align: center;">Using the number line to show that $\frac{4}{3} = \frac{5 \times 4}{5 \times 3}$</p>  <p>$\frac{4}{3}$ is 4 parts when each part is $\frac{1}{3}$, and we want to see that this is also 5×4 parts when each part is $\frac{1}{5 \times 3}$. Divide each of the intervals of length $\frac{1}{3}$ into 5 parts of equal length. There are 5×3 parts of equal length in the unit interval, and $\frac{4}{3}$ is 5×4 of these. Therefore $\frac{4}{3} = \frac{5 \times 4}{5 \times 3} = \frac{20}{15}$.</p> </div>	<ul style="list-style-type: none"> Use a variety of visual area and linear fraction models to recognize and generate equivalent fractions. Explain connections between models and multiplying the numerator and denominator by the same number. Connect visual models to the multiplicative relationships of the numerators and denominators
Images Source: http://commoncoretools.me/wp-content/uploads/2011/08/ccss_progression_nf_35_2013_09_19.pdf	

Extend understanding of equivalence and ordering of fractions (Standards 4.NF.1–2). Denominators for fourth grade are limited to 2, 3, 4, 5, 6, 8, 10, 12, and 100.	
Standard 4.NF.2 Compare two fractions with different numerators and different denominators, <i>for example, by creating common denominators or numerators, or by comparing to a benchmark fraction such as $1/2$</i> . Recognize that comparisons are valid only when the two fractions refer to the same whole. Record the results of comparisons with symbols $>$, $=$, or $<$, and justify the conclusions, <i>for example, by using a visual fraction model</i> .	
Concepts and Skills to Master	
<ul style="list-style-type: none"> • Understand equivalent fractions as the same quantity with different names • Understand comparisons are only valid when the two fractions refer to the same whole • Compare fractions by reasoning that as the number of equal parts in a whole (denominator) increases, the size of the fractional parts decreases and that as the number of equal parts being considered (numerator) increases, the total amount being considered increases • Compare a fraction to a benchmark fraction of $1/2$ and 1 whole • Compare fractions through creating common numerators, multiplying at least one fraction by applying the multiplicative identity property of 1 (any number multiplied by one remains unchanged) • Compare fractions through creating common denominators, multiplying at least one fraction by applying the multiplicative identity property of 1 	
Teacher Note: While denominators at this grade level are limited to 2, 3, 4, 5, 6, 8, 10, 12, and 100, students may be exposed to other denominators based on strategies used to find common denominators.	
Related Standards: Current Grade Level	Related Standards: Future Grade Levels
4.NF.1 Recognize and generate equivalent fractions 4.NF.7 Compare two decimals to hundredths by reasoning about their sizes	5.NF.1 and 2 Use equivalent fractions as a strategy to add and subtract fractions 6.RP.3 Use ratio and rate reasoning to solve problems
Critical Background Knowledge from Previous Grade Levels	
<ul style="list-style-type: none"> • Compare two fractions with the same numerator or the same denominator by reasoning about their size (3.NF.3d) • Denominators are limited to 2, 3, 4, 6, and 8 in third grade • Understand that decomposing into more equal shares creates smaller shares (1.G.3) 	
Academic Vocabulary	
benchmark fraction (half, whole), numerator, denominator, equivalent fractions, compare, $>$, $=$, $<$, equal shares/parts, fraction greater than 1, fractional form Denominators new to fourth grade: fifths ($1/5$), tenths ($1/10$), twelfths ($1/12$), hundredths ($1/100$)	

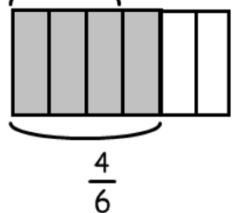
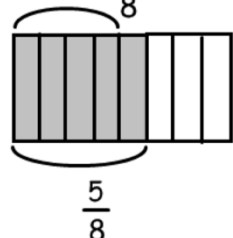
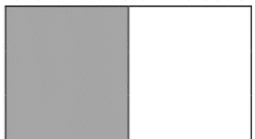
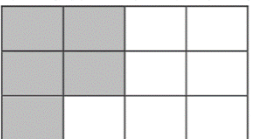
Suggested Models	Suggested Strategies
<p>  </p> <p> $\frac{7}{8} < \frac{13}{12}$ </p> <p>Students reason using benchmarks such as $\frac{1}{2}$ and 1. For example, they see that $\frac{7}{8}$ is less than $\frac{13}{12}$ because $\frac{7}{8}$ is less than 1 (and is therefore to the left of 1 on a number line), but $\frac{13}{12}$ is greater than 1 (and is therefore to the right of 1 on a number line).</p> <p>When using the benchmark fraction of $\frac{1}{2}$ to compare $\frac{4}{6}$ and $\frac{5}{8}$ you can use bar models such as these:</p> <div style="display: flex; justify-content: space-around; align-items: center;"> <div style="text-align: center;"> <p>$\frac{1}{2} + \frac{1}{6}$</p>  <p>$\frac{4}{6}$</p> </div> <div style="text-align: center;"> <p>$\frac{1}{2} + \frac{1}{8}$</p>  <p>$\frac{5}{8}$</p> </div> </div> <p>$\frac{4}{6}$ is $\frac{1}{6}$ larger than $\frac{1}{2}$, while $\frac{5}{8}$ is $\frac{1}{8}$ larger than $\frac{1}{2}$. Since $\frac{1}{6}$ is larger than $\frac{1}{8}$, $\frac{4}{6}$ is the greater fraction.</p> <p>Area model: The first cake has more left over. The second cake has $\frac{5}{12}$ left which is smaller than $\frac{1}{2}$.</p> <div style="display: flex; justify-content: space-around; align-items: center;">   </div>	<ul style="list-style-type: none"> • Use a variety of visual fraction models, such as area models and number lines to compare fractions • Use benchmark fractions to compare fractions • If fractions are the same number of pieces from a whole, compare the size of the missing pieces. This creates opportunities to reason and create common numerators • Create equivalent fractions that have common numerators, and then compare the denominators or the size of the fractional parts to compare the fractions (Example: Have students explore ways of comparing $\frac{2}{3}$ and $\frac{4}{5}$ by finding a common numerator.) • Create equivalent fractions that have common denominators, and then compare the numerators or number of parts being considered (Example: have students explore ways of comparing $\frac{2}{3}$ and $\frac{4}{5}$ by finding a common denominator.)
<p>Images Sources: http://commoncoretools.me/wp-content/uploads/2011/08/ccss_progression_nf_35_2013_09_19.pdf, http://www.dpi.state.nc.us/docs/curriculum/mathematics/scos/4.pdf</p>	

Build fractions from unit fractions by applying and extending previous understandings of operations on whole numbers (Standards 4.NF.3–4). Denominators for fourth grade are limited to 2, 3, 4, 5, 6, 8, 10, 12, and 100.

Standard 4.NF.3 Understand a fraction a/b with $a > 1$ as a sum of fractions $1/b$. In other words, any fraction is a sum of unit fractions.

a. Understand addition and subtraction of fractions as joining and separating parts referring to the same whole.

b. Decompose a fraction into a sum of fractions with the same denominator in more than one way, recording each decomposition by an equation. Justify decompositions, *for example, by using a visual fraction model. For example, $3/8 = 1/8 + 1/8 + 1/8$;*

$3/8 = 1/8 + 2/8$; $2\ 1/8 = 1 + 1 + 1/8$; $2\ 1/8 = 8/8 + 8/8 + 1/8$.

c. Add and subtract mixed numbers with like denominators, *for example, by replacing each mixed number with an equivalent fraction, and/or by using properties of operations and the relationship between addition and subtraction.*

For example, $3\ 1/4 + 2\ 1/4 = 13/4 + 9/4 = 22/4$; $3\ 1/4 + 2\ 1/4 = (3 + 2) + (1/4 + 1/4) = 5 + 2/4 = 5\ 2/4$, which is equivalent to $22/4$.

d. Solve word problems involving addition and subtraction of fractions referring to the same whole and having like denominators, *for example, by using visual fraction models and equations to represent the problem.*

Concepts and Skills to Master

- Understand and represent that addition and subtraction of fractions with the same denominator is joining or separating parts referring to the same whole
- Understand a mixed number is a whole number and a fraction that can also be represented as a fraction greater than one
- Add and subtract fractions with like denominators by replacing each mixed number with an equivalent fraction, and/or by using properties of operations and the relationship between addition and subtraction
- Solve word problems involving addition and subtraction of fractions with like denominators

Teacher Note: All concepts and skills may include fractions greater than one and mixed numbers.

Related Standards: Current Course

- 4.NF.1** Recognize and generate equivalent fractions
4.NF.4 Multiply a fraction by a whole number
4.NF.5 Add fractions with denominators of 10 and 100
4.MD.2 Solve word problems with fraction and decimal numbers
4.MD.4 Make a line plot with measurements in fraction units

Related Standards: Future Courses

- 5.NF.1 and 2** Use equivalent fractions as a strategy to add and subtract fractions.
6.EE.7 Solve real-world and mathematical problems by writing and solving equations of the form $x + a = b$ for cases in which a , b and x are all non-negative rational numbers
6.NS.2–4 Apply and extend previous understandings of numbers to the system of rational numbers

Critical Background Knowledge from Previous Grade Levels

- Understand a unit fraction is a fraction with a numerator of 1 (3.NF.1)
- Understand equivalent fractions (3.NF.3)
- Represent a fraction on a number line (3.NF.2)

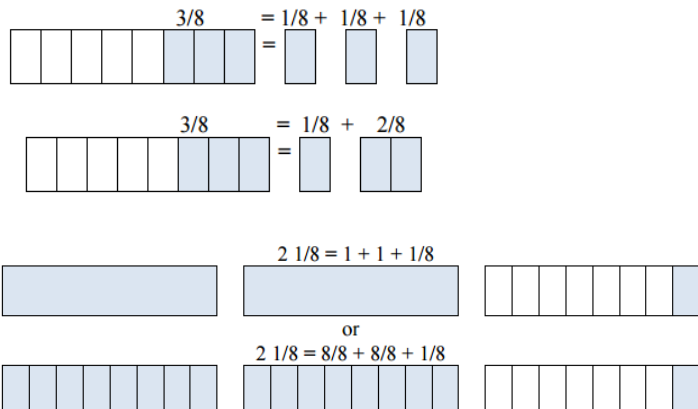
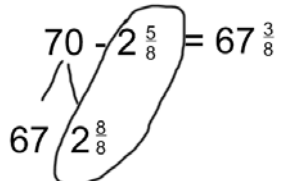
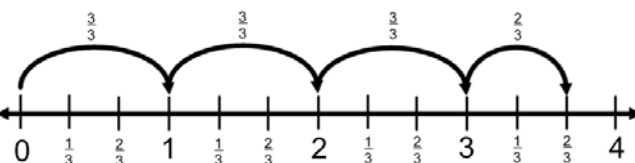

Academic Vocabulary

Compose (composition), decompose (decomposition), unit fraction, mixed numbers, fractional form ($5/4$), fraction greater than one, numerator, denominator

Suggested Models	Suggested Strategies
<p>Bar Model</p>  <p> $\frac{3}{8} = \frac{1}{8} + \frac{1}{8} + \frac{1}{8}$ $\frac{3}{8} = \frac{1}{8} + \frac{2}{8}$ $2 \frac{1}{8} = 1 + 1 + \frac{1}{8}$ or $2 \frac{1}{8} = \frac{8}{8} + \frac{8}{8} + \frac{1}{8}$ </p>	<ul style="list-style-type: none"> • Use visual fraction models such as number bonds, number lines, fraction strips, bar models, tape diagrams, area models, and rulers to add and subtract fractions with like denominators • Connect equations to visual models
<p>Equations (Decompose Fraction)</p> $\frac{5}{3} = \frac{3}{3} + \frac{2}{3} = 1 + \frac{2}{3} = 1\frac{2}{3}$	
<p>Number Bond</p>  $70 - 2\frac{5}{8} = 67\frac{3}{8}$	
<p>Number Line</p>  $3\frac{2}{3} = \frac{9}{3} + \frac{2}{3} = \frac{11}{3}$	

Images Source: <http://www.dpi.state.nc.us/docs/curriculum/mathematics/scos/4.pdf>

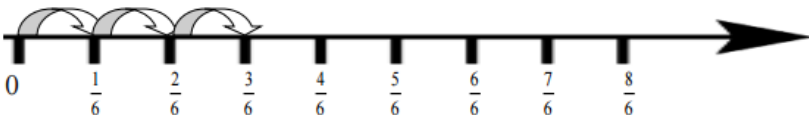
Build fractions from unit fractions by applying and extending previous understandings of operations on whole numbers (Standards 4.NF.3–4). Denominators for fourth grade are limited to 2, 3, 4, 5, 6, 8, 10, 12, and 100.	
<p>Standard 4.NF.4 Apply and extend previous understandings of multiplication to multiply a fraction by a whole number.</p> <p>a. Understand a fraction a/b as a multiple of $1/b$. <i>For example, use a visual fraction model to represent $5/4$ as the product $5 \times (1/4)$, recording the conclusion by the equation $5/4 = 5 \times (1/4)$.</i></p> <p>b. Understand a multiple of a/b as a multiple of $1/b$, and use this understanding to multiply a fraction by a whole number. <i>For example, use a visual fraction model to express $3 \times (2/5)$ as $6 \times (1/5)$, recognizing this product as $6/5$. (In general, $n \times (a/b) = (n \times a)/b$).</i></p> <p>c. Solve word problems involving multiplication of a fraction by a whole number (<i>for example, by using visual fraction models and equations to represent the problem</i>). <i>For example, if each person at a party will eat $3/8$ of a pound of roast beef, and there will be five people at the party, how many pounds of roast beef will be needed? Between what two whole numbers does your answer lie?</i></p>	
<p>Concepts and Skills to Master</p> <ul style="list-style-type: none"> • Understand a non-unit fraction (a fraction with a numerator greater than one) as a multiple of a unit fraction and a whole number • Represent a repeated addition expression with unit fractions as a multiplication expression with a whole number and a unit fraction • Represent a non-unit fraction in an expression of a unit fraction multiplied by a whole number • Understand a multiple of a non-unit fraction is equivalent to a unit fraction times a whole number ($3 \times \frac{2}{5}$ as $6 \times \frac{1}{5}$) • Solve word problems involving multiplication of a fraction and a whole number 	
<p>Related Standards: Current Grade Level</p> <p>4.NF.2 Utilize benchmark fractions to check for reasonableness of an answer</p> <p>4.NF.3 Understand any fraction with a numerator greater than one is the sum of unit fractions</p> <p>4.MD.2 Use multiplication to solve word problems using measurement</p>	<p>Related Standards: Future Grade Levels</p> <p>5.NF.4 Multiply a fraction by a whole number or fraction</p> <p>5.NF.6 Solve real-world fraction multiplication problems</p> <p>5.NF.7 Divide unit fractions by whole numbers and whole numbers by unit fractions</p> <p>6.EE.7 Solve real-world and mathematical problems by writing and solving equations of the form $ax=b$ for cases in which a, b and x are all non-negative rational numbers</p> <p>6.NS.2–4 Compute fluently with multi-digit numbers; find factors and multiples</p>
<p>Critical Background Knowledge from Previous Grade Levels</p> <ul style="list-style-type: none"> • Understand a unit fraction has a numerator of 1 and a non-zero denominator (3.NF.1) • Understand and represent fractions on a number line (3.NF.2) • Interpret the products of whole numbers as the total number of objects in all groups (3.OA.1) • Determine the unknown whole number in a multiplication or division problem (3.OA.4) 	
<p>Academic Vocabulary</p> <p>Unit fraction, multiple, fractional form ($5/4$), fraction greater than one, mixed number, factor, product, expression, equation, numerator, denominator, whole number</p>	

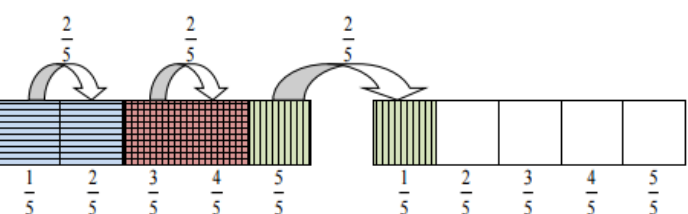
Suggested Models	Suggested Strategies
<p>Number Line</p>  <p>Bar Model</p>  $\frac{3}{6} = \frac{1}{6} + \frac{1}{6} + \frac{1}{6} = 3 \times \frac{1}{6}$ <p>Each person at a party eats $\frac{2}{5}$ of a pound of meat, and there are 3 people at the party. How many pounds of meat are needed? Between what two answers do you answer lie?</p>  $3 \times \frac{2}{5} = \frac{2}{5} + \frac{2}{5} + \frac{2}{5} = 6 \times \frac{1}{5}$	<ul style="list-style-type: none"> • Use a variety of visual fraction models with students when introducing and working with each substandard a, b, and c • Build multiplication and repeated addition equations to represent problems • Use contexts in word problems when making models to evaluate reasonableness of answers • Connect visual models to equations

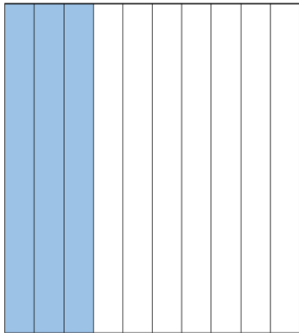
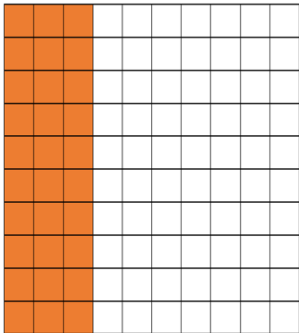
Understand decimal notation to the hundredths and compare decimal fractions with denominators of 10 and 100 (Standards 4.NF.5–7). Denominators for fourth grade are limited to 2, 3, 4, 5, 6, 8, 10, 12, and 100.					
Standard 4.NF.5 Express a fraction with denominator 10 as an equivalent fraction with denominator 100, and use this technique to add two fractions with respective denominators 10 and 100. <i>For example, express $3/10$ as $30/100$, and add $3/10 + 4/100 = 34/100$.</i>					
Concepts and Skills to Master					
<ul style="list-style-type: none"> Understand equivalent fractions as the same quantity with different names. Add fractions with denominators of 10 and 100 Create equivalent fractions using Multiplicative Identity Property Visualize and create base-ten grids to express a fraction with a denominator of 10 or 100 <p>Teacher Note: Student are first exposed to decimal numbers in fourth grade.</p>					
Related Standards: Current Course	Related Standards: Future Courses				
<p>4.NF.1 Equivalent fractions</p> <p>4.NF.3 Add and subtract fractions with like denominators</p> <p>4.NF.6 Use decimal notation for fractions with denominators 10 or 100</p> <p>4.NF.7 Compare two decimals to hundredths by reasoning about their size</p> <p>4.MD.2 Solve measurement word problems involving decimals</p>	<p>5.NBT.1 Recognize that in a multi-digit number, a digit in one place represents 10 times as much as it represents in the place to its right and $1/10$ of what it represents in the place to its left</p> <p>5.NBT.7 Add, subtract, multiply and divide decimals</p>				
Critical Background Knowledge					
<ul style="list-style-type: none"> Related Standards: Current Grade Level (see above) Explain equivalence and generate equivalent fractions (3.NF.3) 					
Academic Vocabulary					
Base-ten fractions, common denominator, equivalent fraction, tenths, hundredths					
Suggested Models	Suggested Strategies				
<div style="text-align: center;"> <table border="1" style="display: inline-table; margin-right: 20px;"> <tr> <td style="padding: 2px 10px;">ones</td> <td style="padding: 2px 5px;">.</td> <td style="padding: 2px 10px;">tenths</td> <td style="padding: 2px 10px;">hundredths</td> </tr> </table> </div> <div style="display: flex; justify-content: space-around; align-items: flex-start;"> <div style="text-align: center;"> <p>Tenths Grid</p>  <p>$0.3 = 3 \text{ tenths} = 3/10$</p> </div> <div style="text-align: center;"> <p>Hundredths Grid</p>  <p>$0.30 = 3 \text{ hundredths} = 3/10$</p> </div> </div>	ones	.	tenths	hundredths	<ul style="list-style-type: none"> Use strategies that explore equivalent fractions with base-ten blocks, base-ten grid models, or grid paper
ones	.	tenths	hundredths		
Image Source: http://www.dpi.state.nc.us/docs/curriculum/mathematics/scos/4.pdf					

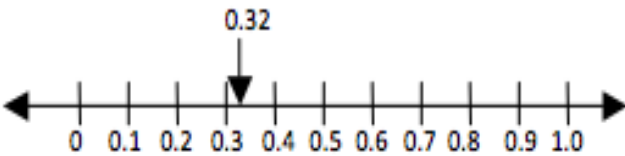
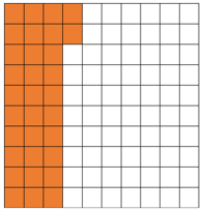
Understand decimal notation to the hundredths and compare decimal fractions with denominators of 10 and 100 (Standards 4.NF.5–7). Denominators for fourth grade are limited to 2, 3, 4, 5, 6, 8, 10, 12, and 100.													
Standard 4.NF.6 Use decimal notation for fractions with denominators 10 or 100. <i>For example, rewrite 0.62 as 62/100, describe a length as 0.62 meters; locate 0.62 on a number line diagram.</i>													
Concepts and Skills to Master													
<ul style="list-style-type: none"> Understand that just as fractions represent part of a whole, decimals represent part of a whole Understand that a fraction represented with decimal notation holds the same value as the fraction Identify the digit to the right of the decimal point as the tenths place and the digit two places to the right of the decimal point at the hundredths place <p>Teacher Note: Being precise with language when saying decimals is important. For example, always say “five and two tenths”, rather than “five point two.” When teachers and students are precise with their language it will provide an opportunity for students to hear the connection between fractions and decimals (Van De Walle, 2014).</p>													
Related Standards: Current Course	Related Standards: Future Courses												
<p>4.NF.5 Express equivalent fractions with denominators of 10 and 100</p> <p>4.NF.7 Compare two decimals to hundredths by reasoning about their size</p> <p>4.MD.2 Solve measurement problems using simple decimals</p>	<p>5.NBT.1 Recognize digits in places as 10 times as much as places to the right, and 1/10 as much as places to the left</p> <p>5.NBT.3 Read, write, and compare decimals to thousandths</p> <p>5.NBT.7 Add, subtract, multiply, and divide with decimals</p>												
Critical Background Knowledge from Previous Grades													
<ul style="list-style-type: none"> Understand that the three digits of a three-digit number represent amounts of hundreds, tens, and ones (2.NBT.1) 													
Academic Vocabulary													
tenths, hundredths, decimal, equivalent fraction, decimal notation													
Suggested Models	Suggested Strategies												
<table border="1" style="margin-bottom: 10px;"> <tr> <td>Hundreds</td> <td>Tens</td> <td>Ones</td> <td>•</td> <td>Tenths</td> <td>Hundredths</td> </tr> <tr> <td></td> <td></td> <td></td> <td>•</td> <td>3</td> <td>2</td> </tr> </table>  	Hundreds	Tens	Ones	•	Tenths	Hundredths				•	3	2	<ul style="list-style-type: none"> Relate fractions and decimals as the same value by using visual models such as base ten blocks and grids, number lines, meter sticks, place value chart and money
Hundreds	Tens	Ones	•	Tenths	Hundredths								
			•	3	2								
Images Source: http://www.dpi.state.nc.us/docs/curriculum/mathematics/scos/4.pdf													

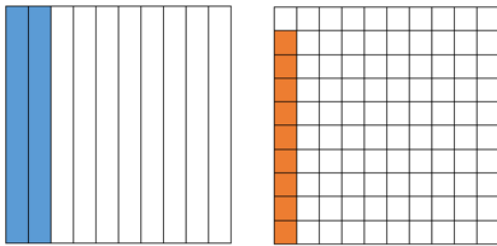
Understand decimal notation to the hundredths and compare decimal fractions with denominators of 10 and 100 (Standards 4.NF.5–7). Denominators for fourth grade are limited to 2, 3, 4, 5, 6, 8, 10, 12, and 100.	
Standard 4.NF.7 Compare two decimals to hundredths by reasoning about their size. Recognize that comparisons are valid only when the two decimals refer to the same whole. Record the results of comparisons with the symbols $>$, $=$, or $<$, and justify the conclusions, <i>for example, by using a visual model.</i>	
Concepts and Skills to Master	
<ul style="list-style-type: none"> Understand comparisons are only valid when the two fractions or decimals refer to the same whole Compare decimals by reasoning that as the number of equal parts in a whole increases, the size of the fractional parts decreases (hundredths are smaller than tenths) Extend place value understanding to tenths and hundredths Create and compare base-ten grids to express a fraction with a denominator of 10 or 100 	
Related Standards: Current Course	Related Standards: Future Courses
4.NBT.2 Read, write, and compare multi-digit whole numbers 4.NF.2 Compare fractions with different numerators and denominators 4.NF.6 Use decimal notation for fractions with denominators 10 or 100	5.NBT.1 Recognize digits in places as 10 times as much as places to the right, and $1/10$ as much as places to the left 5.NBT.3 Read, write, and compare decimals to the thousandths
Critical Background Knowledge from Previous Grade Levels	
<ul style="list-style-type: none"> Compare two fractions with the same numerator or the same denominator by reasoning about their size (3.NF.3d) Compare two three-digit numbers (2.NBT.4) 	
Academic Vocabulary	
decimal, tenth, hundredth, equivalent, $>$, $=$, $<$, compare,	
Suggested Models	Suggested Strategies
<p>Seeing that $0.2 > 0.09$ using a visual fraction model</p>  <p>The shaded region on the left shows 0.2 of the unit square, since it is two parts when the square is divided into 10 parts of equal area. The shaded region on the right shows 0.09 of the unit square, since it is 9 parts when the unit is divided into 100 parts of equal area.</p>	<ul style="list-style-type: none"> Relate and compare fractions and decimals as the same value by using visual models such as base ten blocks and grids, number lines, meter sticks, place value chart and money
Image Source: http://commoncoretools.me/wp-content/uploads/2011/08/ccss_progression_nf_35_2013_09_19.pdf	

Solve problems involving measurement and conversion of measurements from a larger unit to a smaller unit (Standards 4.MD.1–2)	
<p>Standard 4.MD.1 Know relative sizes of measurement units within each system of units (standard and metric), including kilometers, meters, and centimeters; liters and milliliters; kilograms and grams; pounds and ounces; hours, minutes, and seconds. Within a single system of measurement, express measurements in a larger unit in terms of a smaller unit. Record measurement equivalents in a two-column table. <i>For example, know that one foot is 12 times as long as one inch. Express the length of a four-foot snake as 48 inches. Know that one meter is 100 times as long as one centimeter. Generate a conversion table for feet and inches listing the number pairs (1, 12), (2, 24), (3, 36). . .</i></p>	
Concepts and Skills to Master	
<ul style="list-style-type: none"> • Know relative sizes of measurement units using benchmarks and mental images of units introduced in previous grades (see Critical Background Knowledge below) and units new to fourth grade (kilometers, pounds, ounces, and seconds) • Understand that a given measurement can be expressed using different units, yet retain the same value (1 ft. can be represented as 12 in. without altering the value; 1 ft. = 12 in.) • Generalize the relationship between larger and smaller units (1 foot is 12 times as long as one inch) • Convert/Express larger units in terms of smaller units within the same system of measurement using multiplication (converting smaller units to larger units using division begins in fifth grade) <p>Teacher Note: Students should also be exposed to the following units not explicitly listed in the core standards: millimeters, miles, fluid ounces, cups, pints, quarts, and gallons. Students should not be expected to memorize unit conversions; however, knowing relative sizes of measurement units within systems of units and having repeated exposure to commonly used units will support them in being able express measurements in a larger unit in terms of a smaller unit.</p> <p>The core standards do not differentiate between weight and mass. Technically, mass is the amount of matter in an object. Weight is the force exerted on the body of gravity. On the earth’s surface, the distinction is not important. Therefore, mass and weight may be used interchangeably in solving measurement problems related to the standard.</p>	
Related Standards: Current Grade Level	Related Standards: Future Grade Levels
<p>4.MD.2 Solve word problems involving distances, intervals of time, liquid volumes, masses of objects, and money</p> <p>4.OA.1 Interpret a multiplication equation as a comparison</p> <p>4.OA.2 Multiply to solve word problems involving multiplicative comparison</p>	<p>5.MD.1 Use unit conversions in solving multi-step, real world problems</p> <p>6.RP.3.d Use ratio reasoning to convert measurement units; manipulate and transform units appropriately when multiplying or dividing quantities</p>
Critical Background Knowledge	
<ul style="list-style-type: none"> • Distances: Measure lengths with halves and fourths of an inch (3.MD.4); Estimate, measure, add, and subtract lengths using inches, feet, yards, centimeters, and meters (2.MD.1-6) • Liquid Volumes: Measure and estimate masses of objects using grams and kilograms and liquid volumes using milliliters and liters (3.MD.2) • Masses of objects: Measure and estimate; add, subtract, multiply, or divide to solve one-step word problems given the same units (3.MD.2) • Time: Tell and write time to the nearest minute. Add and subtract time intervals in minutes using number line diagrams (3.MD.1); Tell and write time to the nearest 5 minutes using a.m. and p.m. (2.MD.7) 	

Academic Vocabulary

Distances: metric system, distance, length, Kilometer (km), meter (m), centimeter (cm), standard/customary system, mile (mi.), yard (yd.)
feet (ft.) inch (in.)

Liquid volumes: liquid volume, capacity, liter (l), milliliter (ml), gallon (gal.), quart (qt.), pint (pt.), cup (c.), fluid ounce (fl. oz.)

Masses of objects: mass, weight, kilogram (kg), gram (g), pound (lb.), ounce (oz.)

Time: hour (hr.), minute (min.), second (sec.)

Suggested Models

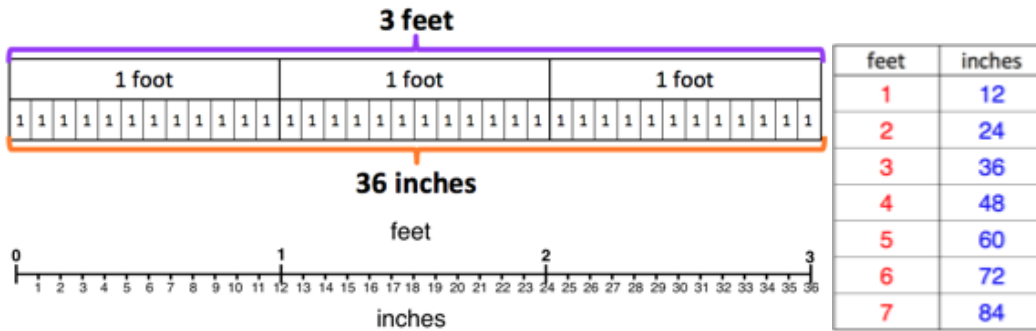

Suggested Strategies

- Measure the same object using two different units, then compare the measurements to the size of the units being used
- Draw pictures and models to generalize conversions (see the image to the left)
- Create a two-column chart or table to notice any patterns for converting within given measurements (see the table to the left)

Solve problems involving measurement and conversion of measurements from a larger unit to a smaller unit (Standards 4.MD.1–2)	
<p>Standard 4.MD.2 Use the four operations to solve word problems involving distances, intervals of time, liquid volumes, masses of objects, and money.</p> <p>a. Include problems involving simple fractions or decimals, and problems that require expressing measurements given in a larger unit in terms of a smaller unit.</p> <p>b. Represent measurement quantities using diagrams such as number line diagrams that feature a measurement scale.</p>	
Concepts and Skills to Master	
<ul style="list-style-type: none"> • Know relative sizes of measurement units using benchmarks and mental images of units introduced in previous grades (see Critical Background Knowledge below) and units new to fourth grade (kilometers, pounds, ounces, and seconds) • Add, subtract, multiply, or divide with whole numbers to solve word problems involving measurement units • Express larger units in terms of smaller units • Add simple decimals including tenths and hundredths in which the sum of the two decimals is less than or equal to 0.99 and NO composing across place values (regrouping) is required ($0.5 + 0.4 = 0.9$; $0.25 + 0.3 = 0.55$). (Students are not expected to operate with decimals outside of these parameters until 5th grade. In 4.NF.5, students add fractions with denominators 10 and 100. In 4.NF.6, students express fractions with denominators 10 and 100 using decimal notation.) • Use decimal notation to represent money ($\\$0.75$ is another notation for 75¢) • Add and subtract simple fractions with like denominators including denominators of 2, 3, 4, 5, 6, 8, 10, 12, or 100 (see 4.NF.3) • Measure time intervals (elapsed time) and solve word problems involving addition and subtraction of time intervals using hours, minutes, and seconds <p>Teacher Note: Students combine competencies from other Strands (Numbers and Operations-Fractions, etc.) to solve measurement problems. The Core Standards do not have an exhaustive list of measurement units students work with. Students should also be exposed to the following units not explicitly listed in the Core Standards: millimeters, miles, fluid ounces, cups, pints, quarts, and gallons. Students should not be expected to memorize unit conversions; however, knowing relative sizes of measurement units within systems of units and having repeated exposure to commonly used units will support them in being able to express measurements in a larger unit in terms of a smaller unit.</p>	
Related Standards: Current Grade Level	Related Standards: Future Grade Levels
<p>4.MD.1 Know relative sizes of measurement units and express units in a larger unit in terms of a smaller unit using a two-column table</p> <p>4.OA.3 Solve multi-step word problems using the four operations</p> <p>4.NF.3 Add and subtract fractions with like denominators</p> <p>4.NF.4 Multiply a fraction by a whole number</p> <p>4.NF.5 Add fractions with denominators of 10 and 100</p> <p>4.NF.6 Use decimal notation for fractions with denominators 10 or 100</p>	<p>5.MD.1 Use unit conversions in solving multi-step, real world problems</p> <p>5.NF.5 Interpret multiplication as scaling</p> <p>6.RP.2 Understand and use unit rates in the context of ratio relationships</p>
Critical Background Knowledge	
<ul style="list-style-type: none"> • Distances: Measure lengths with halves and fourths of an inch (3.MD.4); Estimate, measure, add, and subtract lengths using inches, feet, yards, centimeters, and meters (2.MD.1-6) • Liquid Volumes: Measure and estimate masses of objects using grams and kilograms and liquid volumes using milliliters and liters (3.MD.2) • Masses of objects: Measure and estimate; add, subtract, multiply, or divide to solve one-step word problems given the same units (3.MD.2) • Intervals of time: Tell and write time to the nearest minute. Add and subtract time intervals in minutes using number line diagrams (3.MD.1); Tell and write time to the nearest 5 minutes using a.m. and p.m. (2.MD.7) • Money: Solve word problems involving dollar bills, quarters, dimes, nickels, and pennies using \$ and ¢ symbols (2.MD.8); Identify the value of pennies, nickels, dimes and quarters (1.MD.5) 	

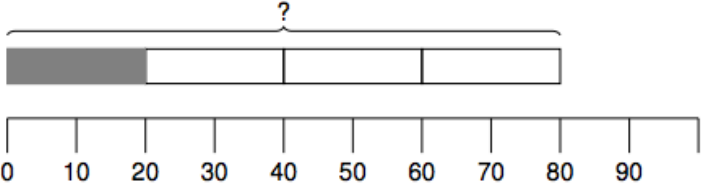
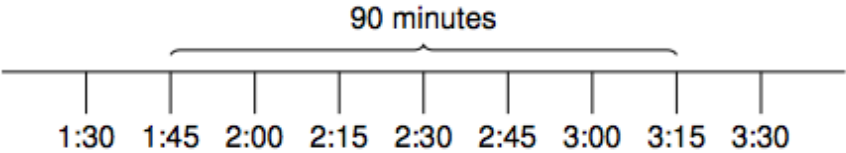
Academic Vocabulary	
<p>Distances: metric system, distance, length, Kilometer (km), meter (m), centimeter (cm), millimeter (mm), standard/customary system, mile (mi.), yard (yd.) feet (ft.) inch (in.)</p> <p>Intervals of time: elapsed time, time interval, hour (hr.), minute (min.), second (sec.)</p> <p>Liquid volumes: liquid volume, capacity, liter (l), milliliter (ml), gallon (gal.), quart (qt.), pint (pt.), cup (c.), fluid ounce (fl. oz.)</p> <p>Masses of objects: mass, weight, kilogram (kg), gram (g), pound (lb.), ounce (oz.)</p> <p>Money: value, dollar (\$), cent (¢)</p>	
Suggested Models	Suggested Strategies
<p>Use number line diagrams to solve word problems</p> <p><i>Juan spent $\frac{1}{4}$ of his money on a game. The game cost \$20. How much money did he have at first?</i></p>  <p><i>What time does Marla have to leave to be at her friend's house by a quarter after 3 if the trip takes 90 minutes?</i></p>  <p>Using a number line diagram to represent time is easier if students think of digital clocks rather than round clocks. In the latter case, placing the numbers on the number line involves considering movements of the hour and minute hands.</p>	<ul style="list-style-type: none"> • Solve measurement word problems including operations of addition, subtraction, multiplication, and division using visual models including number lines, base ten blocks, and drawings • Create a two-column chart or table to notice any patterns for converting within given measurements • Use number line diagrams to solve word problems
Image Source: https://commoncoretools.files.wordpress.com/2012/07/ccss_progression_gm_k5_2012_07_21.pdf	

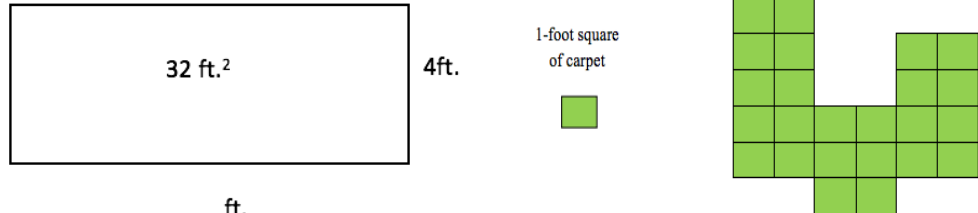
Apply knowledge of area and perimeter to solve real world and mathematical problems (Standard 4.MD.3)	
Standard 4.MD.3 Apply the area and perimeter formulas for rectangles in real-world and mathematical problems. <i>For example, find the width of a rectangular room given the area of the flooring and the length, by viewing the area formula as a multiplication equation with an unknown factor.</i>	
Concepts and Skills to Master	
<ul style="list-style-type: none"> • Apply the area formula to solve real world problems • Apply the perimeter formula(s) to solve real world problems • Understand the meaning of and solve for variables in area and perimeter formulas <p>Teacher Note: "Apply the formula' does not mean write down a memorized formula and put in known values. . . Working with perimeter and area of rectangles is still grounded in specific visualizations and numbers. . . By repeatedly reasoning about constructing situation equations for perimeter and area involving specific numbers and an unknown number, students will build a foundation for applying area, perimeter, and other formulas by substituting specific values for the variables in later grades." (https://commoncoretools.files.wordpress.com/2012/07/ccss_progression_gm_k5_2012_07_21.pdf, p. 22)</p>	
Related Standards: Current Course	Related Standards: Future Courses
<p>4.NBT.4 Fluently add and subtract multi-digit whole numbers</p> <p>4.NBT.5 Multiply a whole number of up to four digits by a one-digit whole number and multiply two two-digit numbers</p> <p>4.OA.3 Solve multi-step word problems with whole numbers</p>	<p>5.MD.5 Relate volume to the operations of multiplication and addition and solve real-world problems involving volume</p> <p>6.G.1 Find the area of right triangles, other triangles, special quadrilaterals, and polygons by composing and decomposing into rectangles, triangles and /or other shapes; apply these techniques in the context of solving real-world problems</p>
Critical Background Knowledge from Previous Grade Levels	
<ul style="list-style-type: none"> • Solve real-world and mathematical problems involving perimeters of polygons, including finding the perimeter given the side lengths, finding an unknown side length, and exhibiting rectangles with the same perimeter and different areas or with the same area and different perimeters (3.MD.8) • Relate area to the operations of multiplication and addition (3.MD.7) • Use multiplication and division within 100 to solve real-world problems (3.OA.3) • Determine the unknown whole number in a multiplication or division equation relating three whole numbers (3.OA.4) • Solve two-step word problems using the four operations using whole numbers (3.OA.8) 	
Academic Vocabulary	
rectangle, perimeter, area, array, unit, square units, rectangular perimeter formula ($P = 2l + 2w$), rectangular area formula ($A = l \times w$)	
Suggested Models	Suggested Strategies
 <p>Mr. Rutherford is covering the miniature golf course with an artificial grass. How many 1-foot squares of carpet will he need to cover the entire course? What is the perimeter of the figure?</p>	<ul style="list-style-type: none"> • Use graph paper or square tiles to make a rectangle with no gaps or overlaps, then count the square units to find the area. Count the side lengths to find the perimeter. Compare these strategies to the formulas. • Solve word problems given an area and one side length by finding the unknown side • Read and discuss measurement word problems to identify when to solve for perimeter or area; solve the problems using models and diagrams
Image Source: http://www.dpi.state.nc.us/docs/curriculum/mathematics/scos/4.pdf	

Represent and interpret data through the use of a line plot (Standard 4.MD.4)	
Standard 4.MD.4 Make a line plot to display a data set of measurements in fractions of a unit (halves, quarters, and eighths). Solve problems involving addition and subtraction with like denominators of fractions by using information presented in line plots. <i>For example, use a line plot to find and interpret the difference in length between the longest and shortest pencils in a classroom.</i>	
Concepts and Skills to Master	
<ul style="list-style-type: none"> • Make a line plot using provided data sets; include a horizontal scale, title, labels, and straight columns of symbols to represent the data points (• or X) • Use a variety of strategies to solve addition and subtraction problems related to data on a line plot <p>Teacher Note: In fourth grade students are not expected to generate measurement data. However, third grade students only measure to the fourth of an inch. This standard is an appropriate place for students to learn to measure to the eighth of an inch.</p>	
Related Standards: Current Grade Level	Related Standards: Future Grade Levels
<p>4.MD.2 Use the four operations to solve word problems, including simple fractions and represent measurement quantities using diagrams</p> <p>4.NF.1 Explain why fractions are equivalent and generate equivalent fractions</p> <p>4.NF.3c Add and subtract mixed numbers with like denominators</p>	<p>5.MD.2 Make line plots with measurements to the half, quarter, and eighth of a unit. Solve problems involving operations of fractions.</p> <p>5.NF.2 Solve real world problems involving the addition and subtraction of fractions referring to the same whole, including cases of unlike denominators</p>
Critical Background Knowledge from Previous Grade Levels	
<ul style="list-style-type: none"> • Generate measurement data by measuring lengths using rulers marked with halves and fourths of an inch. Show the data by making a line plot where the horizontal scale is marked off in appropriate units-whole numbers, halves, or quarters (3.MD.4) • Understand line plots represent measurement data, not categorical data (3.MD.3, 3.MD.4) • Generate measurement data and make line plots using whole number units (2.MD.9) 	
Academic Vocabulary	
line plot, fraction, measurement, data, data set, unit	
Suggested Models	Suggested Strategies
	<ul style="list-style-type: none"> • Generate ideas about what measurement data could be generated and represented on a line plot • Measure physical objects or distances varying in length; use data to create a line plot • Students may use tally marks or data tables to record measurements prior to creating a line plot or they may produce the line plot as the data are being collected
Image Source: http://www.dpi.state.nc.us/docs/curriculum/mathematics/scos/4.pdf	

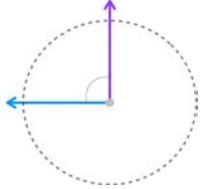
Understand various concepts of angles and angle measurement (Standard 4.MD.5–7).													
<p>Standard 4.MD.5 Recognize angles as geometric figures that are formed wherever two rays share a common endpoint, and understand concepts of angle measurement.</p> <p>a. Understand that an angle is measured with reference to a circle with its center at the common endpoint of the rays, by considering the fraction of the circular arc between the points where the two rays intersect the circle. An angle that turns through $\frac{1}{360}$ of a circle is called a "one-degree angle," and can be used to measure other angles.</p> <p>b. Understand that an angle that turns through n one-degree angles is said to have an angle measure of n degrees.</p>													
<p>Concepts and Skills to Master</p> <ul style="list-style-type: none"> Understand that angles are measured with reference to a circle with its center at the common endpoint of the ray Understand that the arc between the points where the rays intersect is a fraction of the circle Recognize angles as geometric figures that are formed wherever two rays share a common endpoint Understand that a one-degree angle means the angle has turned $\frac{1}{360}$ of a circle Understand that the number of one-degree angles an angle turns through is the number of degrees the angle measures <p>Teacher Note: This standard brings up a connection between angles and circular measurement (360 degrees). In fourth grade students should be exposed to and become familiar with half-circle protractors (physical and digital) with the numbers going in both directions.</p>													
<p>Related Standards: Current Grade Level</p> <p>4.MD.6 Measure angles in whole-number degrees using a protractor</p> <p>4.MD.7 Recognize angle measures as additive and solve to find unknown angles</p> <p>4.G.1 Draw and identify lines and angles</p> <p>4.G.2 Classify two-dimensional figures based on lines and angles</p>	<p>Related Standards: Future Grade Level</p> <p>7.G.2 Construct triangles from three measures of angles</p> <p>7.G.5 Use facts about supplementary, complementary, vertical, and adjacent angles in a multi-step problem to write, and use them to solve simple equations for an unknown angle in a figure</p>												
<p>Critical Background Knowledge from Previous Grade Levels</p> <ul style="list-style-type: none"> Students recognize the number of angles in shapes in previous grade levels, but measuring angles is not addressed in previous grades Understand that shapes in different categories may share attributes (3.G.1) Recognize and draw shapes having specified attributes, such as a given number of angles (2.G.1) 													
<p>Academic Vocabulary</p> <p>circular arc, angle, vertex, circle, ray, degree, degree symbol ($^{\circ}$), endpoint, one-degree, 360°, center, fraction</p>													
<p>Suggested Models</p> <p>Pose the question: A water sprinkler rotates one-degree at each interval. If the sprinkler rotates a total of 100°, how many one-degree turns has the sprinkler made?</p>  <table border="1" data-bbox="508 1263 949 1416"> <caption>An angle</caption> <thead> <tr> <th>name</th> <th>measurement</th> </tr> </thead> <tbody> <tr> <td>right angle</td> <td>90°</td> </tr> <tr> <td>straight angle</td> <td>180°</td> </tr> <tr> <td>acute angle</td> <td>between 0 and 90°</td> </tr> <tr> <td>obtuse angle</td> <td>between 90° and 180°</td> </tr> <tr> <td>reflex angle</td> <td>between 180° and 360°</td> </tr> </tbody> </table>	name	measurement	right angle	90°	straight angle	180°	acute angle	between 0 and 90°	obtuse angle	between 90° and 180°	reflex angle	between 180° and 360°	<p>Suggested Strategies</p> <ul style="list-style-type: none"> Connect prior knowledge of clocks to the concept of 360° in a circle Use arms to make angles Use a variety of manipulatives to demonstrate angle rotations for example licorice, cardboard and brad fastener, straws, clay, etc. Find, identify, and discover examples of angles in the classroom or environment
name	measurement												
right angle	90°												
straight angle	180°												
acute angle	between 0 and 90°												
obtuse angle	between 90° and 180°												
reflex angle	between 180° and 360°												
<p>Image Source: Advantage Math Davis School District, https://www.cgcs.org/cms/lib/DC00001581/Centricity/Domain/120/ccss_progression_gm_k5_2012_07_21.pdf</p>													

Understand various concepts of angles and angle measurement (Standard 4.MD.5–7).	
Standard 4.MD.6 Measure angles in whole-number degrees using a protractor. Sketch angles of specified measure.	
Concepts and Skills to Master	
<ul style="list-style-type: none"> • Understand how use a protractor to measure angles • Measure angles in whole-number degrees with a protractor • Sketch angles of specified measures with a protractor • Understand benchmark angles: 0°, 45°, 90°, 180°, 360° • Read notation to name angles $\angle ABC$ • Read different notations of angle measures (90° is the same as \square) <p>Teacher Note: Before students begin measuring angles with protractors, they need experience with benchmark angles. They transfer their understanding that a 360° rotation about a point makes a complete circle to recognize and sketch angles that measure approximately 90° and 180°. They extend this understanding to recognize and sketch angles that measure approximately 45° and 30°. In fourth grade students should be exposed to and become familiar with half-circle protractors (physical and digital) with the numbers going in both directions. Students are only required to read the angle notation, $\angle ABC$, not create it.</p>	
Related Standards: Current Grade Level	Related Standards: Future Grade Level
<p>4.G.1 Draw and identify lines and angles</p> <p>4.G.2 Classify shapes by properties of their lines and angles</p> <p>4.MD.5 Recognize and understand angles in reference to a circle</p> <p>4.MD.7 Recognize angle measures as additive and solve to find unknown angles</p>	<p>7.G.2 Construct triangles from three measures of angles</p> <p>7.G.5 Use facts about supplementary, complementary, vertical, and adjacent angles in a multi-step problem to write, and use them to solve simple equations for an unknown angle in a figure</p>
Critical Background Knowledge from Previous Grade Levels	
<ul style="list-style-type: none"> • Students recognize the number of angles in shapes in previous grade levels, but measuring angles is not addressed in previous grades • Understand that shapes in different categories may share attributes (3.G.1) • Recognize and draw shapes having specified attributes, such as a given number of angles (2.G.1) 	
Academic Vocabulary	
angle, $\angle ABC$, degree, degree symbol ($^\circ$), ray, protractor, acute, and obtuse, benchmark angles: 0° , 45° , right \square 90° , straight 180° , circle 360°	

Suggested Models

Students should measure and sketch angles.

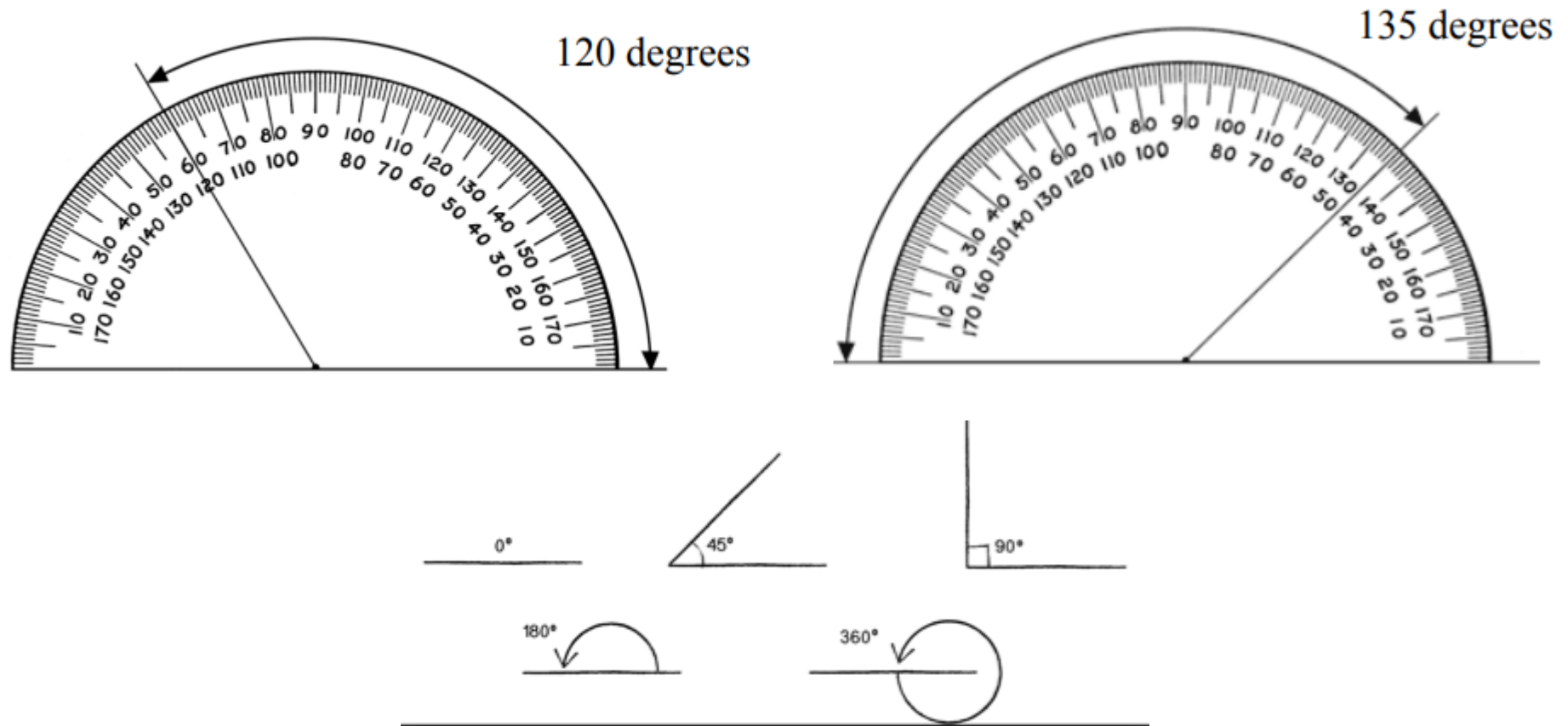

Suggested Strategies

- Draw an angle that measures a given number of degrees
- Show angles in multiple orientations
- Give students an angle and have them estimate the degree of the angle using their understanding of benchmark angles
- Invite students to use an index card marked 90° or a protractor to measure angles in the classroom that are exactly 90°, less than 90°, and more than 90°

Image Source: <http://www.dpi.state.nc.us/docs/curriculum/mathematics/scos/4.pdf>

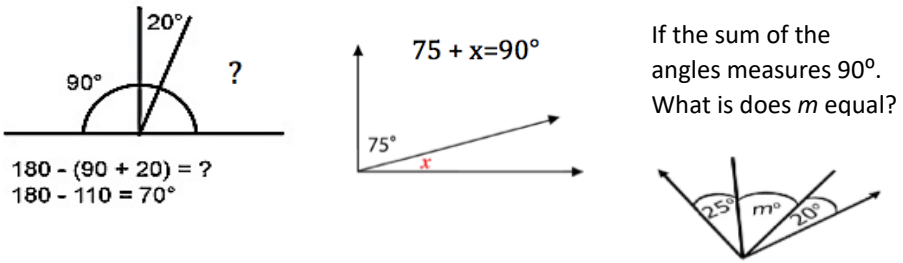
Understand various concepts of angles and angle measurement (Standard 4.MD.5–7).	
Standard 4.MD.7 Recognize angle measure as additive.	
<p>a. Understand that when an angle is decomposed into non-overlapping parts, the angle measure of the whole is the sum of the angle measures of the parts.</p> <p>b. Solve addition and subtraction problems to find unknown angles on a diagram in real-world and mathematical problems, <i>for example by using an equation with a symbol for the unknown angle measure.</i></p>	
Concepts and Skills to Master	
<ul style="list-style-type: none"> Understand two non-overlapping (adjacent) angles can be added together to find the sum of both angles Recognize angle measure as additive Solve addition and subtraction problems to find unknown angles in real-world situations 	
Teacher Note: Students are only required to read the angle notation, $\angle ABC$, not create it. Angles labeled with measures are not always drawn to scale.	
Related Standards: Current Grade-Level	Related Standards: Future Grade-Levels
<p>4.MD.5 Recognize and understand angles in reference to a circle</p> <p>4.MD.6 Measure angles in whole-number degrees using a protractor</p>	<p>7.G.2 Construct triangles from three measures of angles</p> <p>7.G.5 Use facts about supplementary, complementary, vertical, and adjacent angles in a multi-step problem to write, and use them to solve simple equations for an unknown angle in a figure</p>
Critical Background Knowledge from Previous Grade Levels	
<ul style="list-style-type: none"> Students recognize the number of angles in shapes in previous grade levels, but measuring angles is not addressed in previous grades Understand that shapes in different categories may share attributes (3.G.1) Recognize and draw shapes having specified attributes, such as a given number of angles (2.G.1) Use addition and subtraction within 100 to solve one- and two-step word problem (2.OA.1) Find the unknown whole number using addition and subtraction (1.OA.8) 	
Academic Vocabulary	
additive, decompose, non-overlapping (adjacent), angle, sum, degree, degree symbol $^\circ$, acute angle, obtuse angle, straight angle, right angle, angle measure, perpendicular	
Suggested Models	Suggested Strategies
 <p>180 - (90 + 20) = ? 180 - 110 = 70$^\circ$</p> <p>75 + x = 90$^\circ$</p> <p>If the sum of the angles measures 90$^\circ$. What is does m equal?</p>	<ul style="list-style-type: none"> Solve problems such as the following: A lawn water sprinkler rotates 50 degrees and then pauses. It then rotates an additional 25 degrees. What is the total degrees the sprinkler has rotated? If the water sprinkler rotates a total of 25 degrees then pauses. How many 25 degree cycles will it go through for the rotation to reach at least 90 degrees?
Image Source: http://www.dpi.state.nc.us/docs/curriculum/mathematics/scos/4.pdf	

Draw and identify lines and angles, as well as classify shapes by properties of their lines and angles (Standards 4.G.1–3).

Standard 4.G.1 Draw points, lines, line segments, rays, angles (right, acute, and obtuse), and perpendicular and parallel lines. Identify these in two-dimensional figures.

Concepts and Skills to Master

- Draw points, lines, line segments, rays, angles (right, acute, and obtuse), perpendicular and parallel lines
- Identify points, lines, line segments, rays, angles (right, acute, and obtuse), perpendicular and parallel lines in two-dimensional figures

Teacher Note: In third grade students informally recognize attributes of quadrilaterals, including parallel lines and right angles. Although students need to develop explicit awareness of and vocabulary for many concepts they have been developing, including points, lines, line segments, rays, angles (right, acute, obtuse), and perpendicular and parallel lines, it is more important that they construct examples of these concepts. For example, drawing angles and triangles that are acute, obtuse, and right, will help students form a richer conceptual understanding of how these images are connected to their verbal definitions. (http://commoncoretools.me/wp-content/uploads/2014/12/ccss_progression_gk6_2014_12_27.pdf)

Related Standards: Current Grade Level	Related Standards: Future Grade Levels
--	--

4.G.2 Classify two-dimensional figures based on the presence or absence of parallel or perpendicular lines, or the presence or absence of angles of a specified size. Recognize right triangles as a category, and identify right triangles

4.MD.5 Recognize angles as geometric figures that are formed wherever two rays share a common endpoint, and understand concepts of angle measurement

5.G.3 Understand that attributes belonging to a category of two-dimensional figures all belong to all subcategories of that category

5.G.4 Classify two-dimensional figures in a hierarchy based on properties









Critical Background Knowledge from Previous Grade Levels

- Understand that shapes in different categories may share attributes, and that the shared attributes can define a larger category. Recognize rhombuses, rectangles, and squares as examples of quadrilaterals, and draw examples of quadrilaterals that do not belong to any of these subcategories (3.G.1)
- Recognize and draw shapes having specified attributes, such as a given number of sides of angles. Identify and describe quadrilaterals, squares, rectangles, and trapezoids (2.G.1)
- Identify and distinguish between defining attributes versus non-defining attributes; build and draw shapes that possess defining attributes (1.G.1)
- Students work with trapezoids, squares, rectangles, triangles, circles, and hexagons in first and second grade. The term *quadrilateral* is introduced in second grade. Rhombuses and parallelograms are introduced in third grade.

Academic Vocabulary

point, line, line segment, ray, angle (\angle), obtuse, acute, right, parallel (\parallel), perpendicular (\perp), two-dimensional, figure, attribute, angle, closed figure, faces, polygon, rhombus, rectangle, side, square, parallel, parallelogram, quadrilateral, trapezoid, vertex, right angle (\square)

Teacher Note: Rectilinear figures must have four right angles. Ensure that correct plural forms of vocabulary words are used. The plural form for rhombus may be rhombuses or rhombi (may be used interchangeably). The plural form for vertex is vertices.

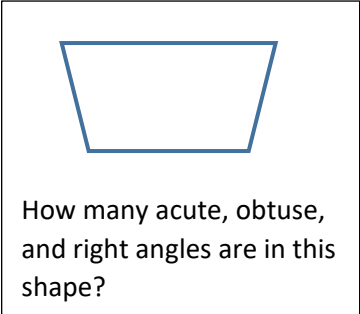
Suggested Models		Suggested Strategies
<p>right angle </p> <p>acute angle </p> <p>obtuse angle </p> <p>straight angle </p> <p>segment </p> <p>line </p> <p>ray </p> <p>parallel lines </p> <p>perpendicular lines </p>	 <p>How many acute, obtuse, and right angles are in this shape?</p>	<ul style="list-style-type: none"> • Draw points, lines, line segments, rays, angles, perpendicular and parallel lines • Use highlighters to find points, lines, line segments, rays, angles, perpendicular and parallel lines in 2-dimensional shapes • Draw and list the properties of a given shape. Draw and list the properties of another shape. How are your drawings and lists alike? How are they different? Be ready to share your thinking with the class. • Draw uppercase the letters of the alphabet to identify points, lines, line segments, rays, angles, perpendicular and parallel lines
<p>Image Source: http://www.dpi.state.nc.us/docs/curriculum/mathematics/scos/4.pdf</p>		

<p>Draw and identify lines and angles, as well as classify shapes by properties of their lines and angles (Standards 4.G.1–3)</p>	
<p>Standard 4.G.2 Classify two-dimensional figures based on the presence or absence of parallel or perpendicular lines, or the presence or absence of angles of a specified size. Recognize right triangles as a category, and identify right triangles.</p>	
<p>Concepts and Skills to Master</p> <ul style="list-style-type: none"> • Classify two-dimensional figures based on the presence or absence of parallel or perpendicular lines • Classify two-dimensional figures based on the presence or absence of angles of a specified size • Identify right triangles (any triangle with an angle measuring 90 degrees). • Use side length to classify triangles as equilateral, equiangular, isosceles, or scalene • Use angle size to classify them as acute, right, or obtuse <p>Teacher Note: Students may be exposed to the terms equilateral, isosceles, and scalene to describe triangles.</p>	
<p>Related Standards: Current Grade Level</p> <p>4.G.1 Understand that shapes in different categories may share attributes , and that the shared attributes can define a larger category</p> <p>4.MD.5 Recognize angles as geometric figures that are formed wherever two rays share a common endpoint, and understand concepts of angle measurement</p> <p>4.MD.6 Measure angles in whole-number degrees using a protractor</p>	<p>Related Standards: Future Grade Levels</p> <p>5.G.3 Understand that attributes belonging to a category of two-dimensional figures all belong to all subcategories of that category.</p> <p>5.G.4 Classify two-dimensional figures in a hierarchy based on properties.</p> <p>G.6.1 Students need to identify right triangles</p>
<p>Critical Background Knowledge from Previous Grade Levels</p> <ul style="list-style-type: none"> • Understand that shapes in different categories may share attributes, and that the shared attributes can define a larger category. Recognize rhombuses, rectangles, and squares as examples of quadrilaterals, and draw examples of quadrilaterals that do not belong to any of these subcategories. (3.G.1) • Recognize and draw shapes having specified attributes, such as a given number of sides of angles. Identify and describe quadrilaterals, squares, rectangles, and trapezoids (2.G.1) • Identify and distinguish between defining attributes versus non-defining attributes; build and draw shapes that possess defining attributes (1.G.1) • Students work with trapezoids, squares, rectangles, triangles, circles, and hexagons in first and second grade. The term <i>quadrilateral</i> is introduced in second grade. Rhombuses and parallelograms are introduced in third grade. 	
<p>Academic Vocabulary</p> <p>classify, right triangle, parallel line, perpendicular line, acute angle, obtuse angle, right angle, two-dimensional figure</p>	

Suggested Models

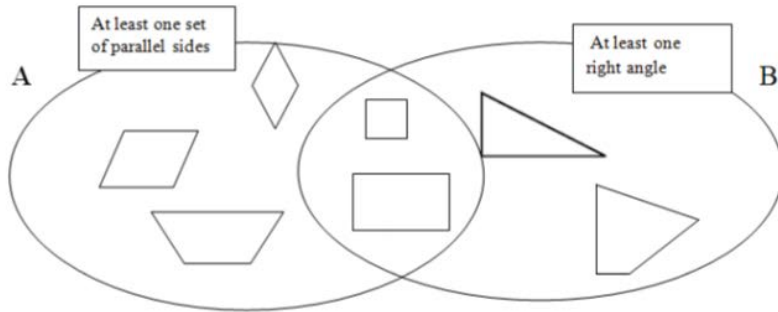

	Closed shape	4 sides	Opposite sides parallel	Perpendicular line segments	Opposite sides congruent	All sides congruent	Right angle(s)	Acute angle(s)	Obtuse angle(s)

Suggested Strategies

- Use graphic organizers such as Venn diagrams, t-charts, etc.
- Play “Guess My Rule”. Select a rule (for example quadrilaterals) start to sort a given set of shapes. Slowly add shapes to the sort. After each shape is added students guess the rule.
- Sort for examples and non-examples of a given attribute

Image Sources: <http://www.dpi.state.nc.us/docs/curriculum/mathematics/scos/4.pdf>; <https://www.illustrativemathematics.org/content-standards/4/G/A/2/tasks/1275>

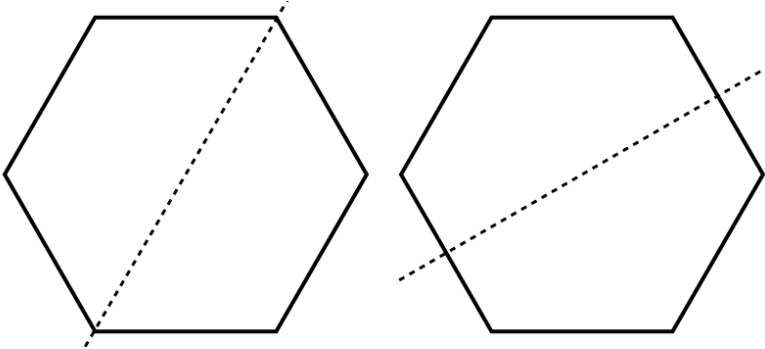
<p>Draw and identify lines and angles, as well as classify shapes by properties of their lines and angles (Standards 4.G.1–3).</p>	
<p>Standard 4.G.3 Recognize a line of symmetry for a two-dimensional figure as a line across the figure such that the figure can be folded along the line into matching parts. Identify line-symmetric figures and draw lines of symmetry.</p>	
<p>Concepts and Skills to Master</p> <ul style="list-style-type: none"> • Recognize the meaning of a line of symmetry as a line that separates two matching parts in a figure • Draw lines of symmetry within a figure • Identify whether or not a figure has a line of symmetry <p>Teacher Note: Fourth grade work is limited to line symmetry. Rotational symmetry, also referred to as point symmetry, is introduced in eighth grade.</p>	
<p>Related Standards: Current Grade Level</p> <p>There are no directly related standards in this grade level, although recognizing symmetry may related to drawing and classifying shapes (4.G.1. 4.G.2)</p>	<p>Related Standards: Future Grade Levels</p> <p>8.G.2 Understand congruence by a sequence of rotations, reflection, and translations</p>
<p>Critical Background Knowledge from Previous Grade Levels</p> <ul style="list-style-type: none"> • Partition shapes into halves (2.G.3, 1.G.3) • Compose two-dimensional shapes (1.G.2) 	
<p>Academic Vocabulary</p> <p>symmetry, matching parts, line, line of symmetry, symmetrical</p>	
<p>Suggested Models</p> 	<p>Suggested Strategies</p> <ul style="list-style-type: none"> • Use tracing paper to trace a shape and fold along the line of symmetry to recognize the matching parts • Sort shapes into “shapes with a line of symmetry” and “shapes those without a line a symmetry” • Use a geometry mirror to explore whether or not a shape has a line of symmetry • Use geoboards or dot grids to explore shapes and identify whether or not a line of symmetry exists • Find all of the lines of symmetry in a given shape